

XYZs of Signal Sources



COMPUTING

COMMUNICATIONS

VIDEO

XYZs of Signal Sources



XYZs of Signal Sources

▶ Primer

▶ XYZs of Signal Sources

▶ Contents

▶ The Complete Measurement System	4
▶ The Signal Source	6
Analog or Digital?	6
▶ Basic Signal Source Applications	7
Verification	7
Analyzing Digital Modulation	7
Characterization	7
Testing D/A and A/D Converters	7
Stress/Margin Testing	7
Stressing Communication Receivers	7
Signal Generation Techniques	7
▶ Understanding Waveforms	8
Waveform Characteristics	8
Amplitude, Frequency, and Phase	8
Rise and Fall Time	8
Pulse Width	9
Offset	10
Differential vs. Single-ended Signals	10
Basic Waves	11
Sine Waves	11
Square And Rectangular Waves	11
Sawtooth and Triangle Waves	12
Step and Pulse Shapes	12
Complex Waves	13
Signal Modulation	13
Analog Modulation	13
Digital Modulation	13
Quadrature Modulation	14
Digital Patterns and Formats	14
Bit Streams	14

- ▶ **Types of Signal Sources** **15**
- ▶ **Analog and Mixed Signal Sources** **16**
 - Types of Analog and Mixed Signal Generators** **16**
 - Arbitrary Generators 16
 - Arbitrary Function Generator (AFG) 16
 - Arbitrary Waveform Generator (AWG) 17
 - The Systems and Controls of a Mixed Signal Source** **19**
 - Performance Terms and Considerations** **20**
 - Memory Depth (Record Length) 20
 - Sample (Clock) Rate 20
 - Bandwidth 21
 - Vertical (Amplitude) Resolution 22
 - Horizontal (Timing) Resolution 23
 - Region Shift 23
 - Output Channels 24
 - Digital Outputs 24
 - Filtering 25
 - Sequencing 25
 - Integrated Editors 26
 - Data Import Functions 27
 - Built-in Applications 27
 - Creating Waveforms Using Mixed Signal Sources** **28**
- ▶ **Logic Signal Sources** **29**
 - Types of Logic Signal Sources** **29**
 - Pulse Generator 29
 - Pattern Generator 29
 - The Systems and Controls of a Logic Signal Source** **33**
 - Performance Terms and Considerations** **35**
 - Data Rate 35
 - Pattern Depth 35
 - Rise/Fall Time 35
 - Vertical (Amplitude) Resolution 35
 - Horizontal (Timing) Resolution 35
 - Output Channels 35
 - Sequencing 35
 - Integrated Editors 35
 - Data Import Functions 35
 - Creating Waveforms Using a Logic Signal Source** **36**
- ▶ **Conclusion** **37**
- ▶ **Glossary** **38**

XYZs of Signal Sources

▶ Primer

▶ The Complete Measurement System

An acquisition instrument – usually an oscilloscope or logic analyzer – is probably the first thing that comes to mind when you think about making electronic measurements. But these tools can only make a measurement when they are able to acquire a signal of some kind. And there are many instances in which no such signal is available unless it is externally provided.

A strain gauge amplifier, for example, does not produce signals; it merely increases the power of the signals it receives from a sensor. Similarly, a multiplexer on a digital address bus does not originate signals; it directs signal traffic from counters, registers, and other elements. But inevitably it becomes necessary to test the amplifier or multiplexer before it is connected to the circuit that feeds it. In order to use an acquisition instrument to measure the behavior of such devices, you must provide a stimulus signal at the input.

To cite another example, engineers must characterize their emerging designs to ensure that the new hardware meets design specifications across the full range of operation and beyond. This is known as margin or limit testing. It is a measurement task that requires a complete solution; one that can generate signals as well as make measurements. The toolset for digital design characterization differs from its counterpart in analog/mixed signal design, but both must include stimulus instruments and acquisition instruments.

The signal source, or signal generator, is the stimulus source that pairs with an acquisition instrument to create the two elements of a complete measurement solution. The two tools flank the input and output terminals of the device-under-test (DUT) as shown in

Figure 1. In its various configurations, the signal source can provide stimulus signals in the form of analog waveforms, digital data patterns, modulation, intentional distortion, noise, and more. To make effective design, characterization, or troubleshooting measurements, it is important to consider both elements of the solution.

The purpose of this document is to explain signal sources, their contribution to the measurement solution as a whole, and their applications. Understanding the many types of signal sources and their capabilities is essential to your work as a researcher, engineer, or technician. Selecting the right tool will make your job easier and will help you produce fast, reliable results.

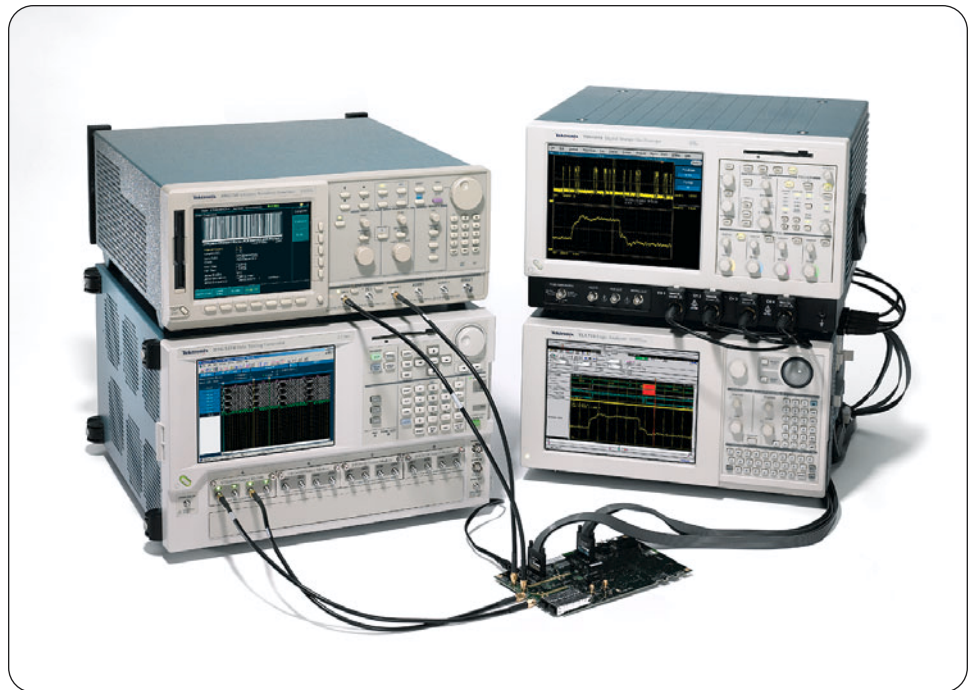

▶ **Figure 1.** Most measurements require a solution made up of a signal source paired with an acquisition instrument. Triggering connectivity simplifies capturing of the DUT output signal.

After reading this primer, you will be able to:

- ▶ Describe how signal sources work
- ▶ Describe electrical waveform types
- ▶ Describe the differences between mixed signal sources and logic signal sources
- ▶ Understand basic signal source controls
- ▶ Generate simple waveforms

Should you need additional assistance, or have any comments or questions about the material in this primer, simply contact your Tektronix representative, or visit www.tektronix.com/signal_sources.

XYZs of Signal Sources

▶ Primer

▶ The Signal Source

The signal source is exactly what its name implies: a source of signals used as a stimulus for electronic measurements. Most circuits require some type of input signal whose amplitude varies over time. The signal may be a true bipolar AC¹ signal (with peaks oscillating above and below a ground reference point) or it may vary over a range of DC offset voltages, either positive or negative. It may be a sine wave or other analog function, a digital pulse, a binary pattern, or a purely arbitrary wave shape.

The signal source can provide “ideal” waveforms or it may add known, repeatable amounts and types of distortion (or errors) to the signal it delivers. See Figure 2. This characteristic is one of the signal source’s greatest virtues, since it is often impossible to create predictable distortion exactly when and where it’s needed using only the circuit itself. The response of the DUT in the presence of these distorted signals reveals its ability to handle stresses that fall outside the normal performance envelope.

Analog or Digital?

Most signal sources today are based on digital technology. Many can fulfill both analog and digital requirements, although the most efficient solution is usually a source whose features are optimized for the application at hand – either analog or digital.

Arbitrary waveform generators (AWG) and function generators are aimed primarily at analog and mixed-signal applications. These instruments use sampling techniques to build and modify waveforms of almost any imaginable shape. Typically these generators have from 1 to 4 outputs. In some AWGs, these main sampled analog outputs are supplemented by separate marker outputs (to aid triggering of external instruments) and synchronous digital outputs that present sample-by-sample data in digital form.

Digital waveform generators (logic sources) encompass two classes of instruments. Pulse generators drive a stream of square waves or pulses from a small number of outputs, usually at very high frequencies. These tools are most commonly used to exercise high-speed digital equipment. Pattern generators, also known as data generators or data timing generators, typically provide 8, 16, or even more synchronized digital pulse streams as a stimulus signal for computer buses, digital telecom elements, and more.

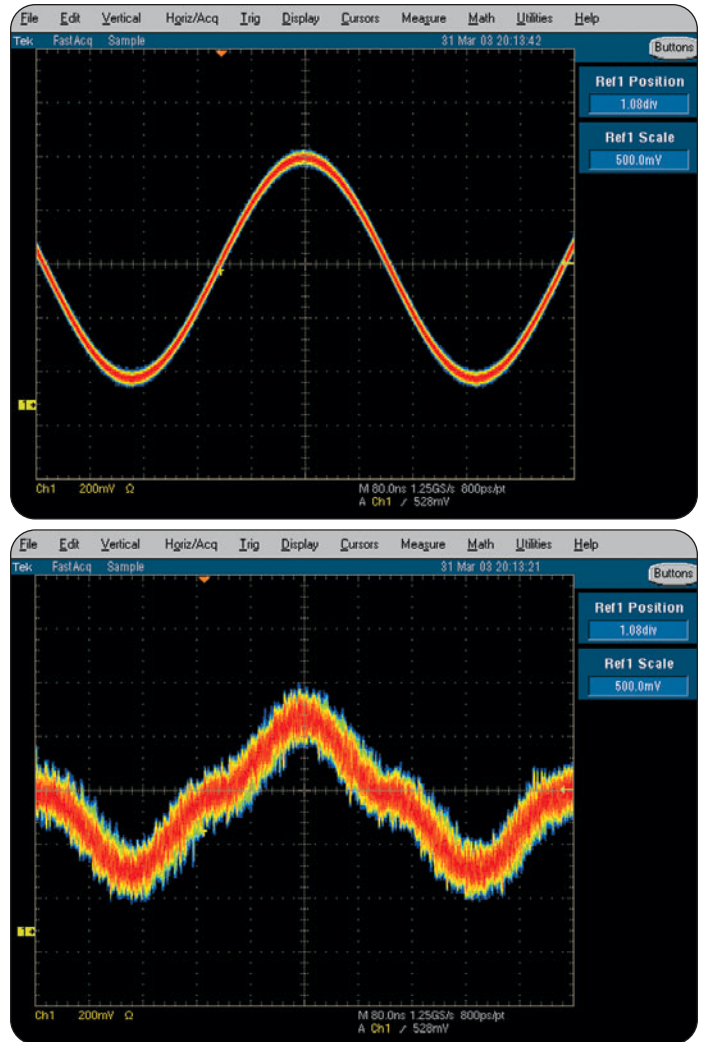

▶ **Figure 2.** (Top) Ideal waveform; (Bottom) “Real-world” waveform. A versatile signal source can provide controlled distortions and aberrations for stress testing and characterization of devices.

¹ Normally, the term “AC” denotes a signal that goes positive and negative about a 0 volt (ground) reference and therefore reverses the direction of current flow once in every cycle. For the purposes of this discussion, however, AC is defined as any varying signal, irrespective of its relationship to ground. For example, a signal that oscillates between +1 V and +3 V, even though it always draws current in the same direction, is construed as an AC waveform. Most signal sources can produce either ground-centered (true AC) or offset waveforms.

► Basic Signal Source Applications

Signal sources have hundreds of different applications but in the electronic measurement context they fall into three basic categories: verification, characterization, and stress/margin testing. Some representative applications include:

Verification

Analyzing Digital Modulation

Wireless equipment designers developing new transmitter and receiver hardware must simulate baseband I&Q signals – with and without impairments – to verify conformance with emerging and proprietary wireless standards. Some high-performance arbitrary waveform generators can provide the needed low-distortion, high-resolution signals at rates up to 1 gigabit per second (1 Gbps), with two independent channels, one for the “I” phase and one for the “Q” phase.

Characterization

Testing D/A and A/D Converters

Newly-developed digital-to-analog converters (DAC) and analog-to-digital converters (ADC) must be exhaustively tested to determine their limits of linearity, monotonicity, and distortion. A state-of-the-art AWG can generate simultaneous, in-phase analog and digital signals to drive such devices at speeds up to 1 Gbps.

Stress/Margin Testing

Stressing Communication Receivers

Engineers working with serial data stream architectures (commonly used in digital communications buses and disk drive amplifiers) need to stress their devices with impairments, particularly jitter and timing violations. Advanced

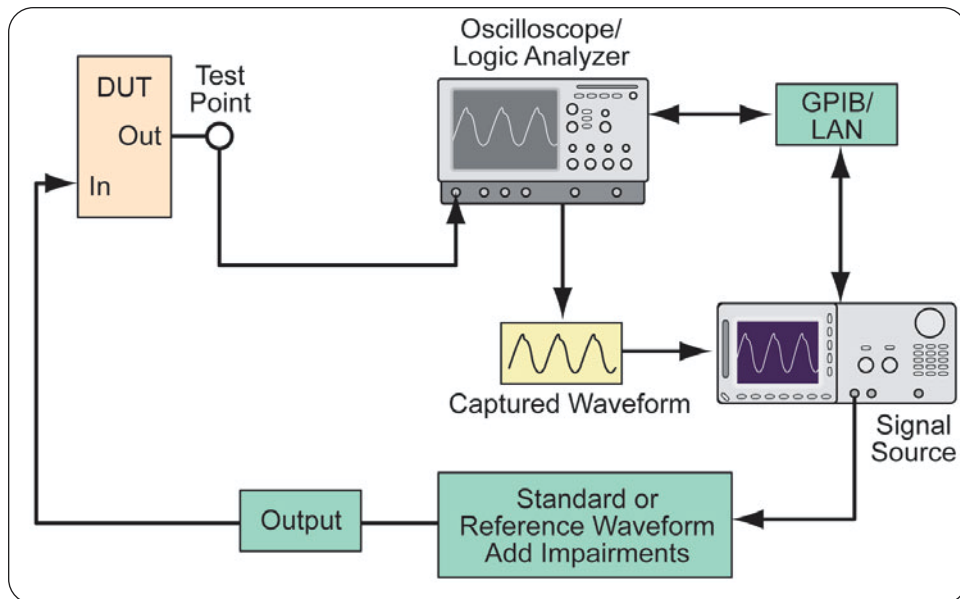

► **Figure 3.** Signal sources can use standard, user-created, or captured waveforms, adding impairments where necessary for special test applications.

signal sources save the engineer untold hours of calculation by providing efficient built-in jitter editing and generation tools. These instruments can shift critical signal edges as little as 300 fs (0.3 ps).

Signal Generation Techniques

There are several ways to create waveforms with a signal source. The choice of methods depends upon the information available about the DUT and its input requirements; whether there is a need to add distortion or error signals, and other variables. Modern high-performance signal sources offer at least three ways to develop waveforms:

- **Simulation:** “Building” an event or sequence of events, based on a specific waveform definition (often from a simulator or a library of waveforms)
- **Replication:** Capturing an existing signal on an oscilloscope and sending it to the signal source for reproduction (Figure 3)
- **Substitution:** Creating and/or modifying a defined signal to substitute for a signal from unavailable circuitry (Figure 3)

XYZs of Signal Sources

▶ Primer

▶ Understanding Waveforms

Waveform Characteristics

The term “wave” can be defined as a pattern of varying quantitative values that repeats over some interval of time. Waves are common in nature: sound waves, brain waves, ocean waves, light waves, voltage waves, and many more. All are periodically repeating phenomena. Signal sources are usually concerned with producing electrical (typically voltage) waves that repeat in a controllable manner.

Each full repetition of a wave is known as a “cycle.” A waveform is a graphic representation of the wave’s activity – its variation over time. A voltage waveform is a classic Cartesian graph with time on the horizontal axis and voltage on the vertical axis. Note that some instruments can capture or produce current waveforms, power waveforms, or other alternatives. In this document we will concentrate on the conventional voltage vs. time waveform.

Amplitude, Frequency, and Phase

Waveforms have many characteristics but their key properties pertain to amplitude, frequency, and phase:

- ▶ **Amplitude:** A measure of the voltage “strength” of the waveform. Amplitude is constantly changing in an AC signal. Signal sources allow you to set a voltage range, for example, -3 to $+3$ volts. This will produce a signal that fluctuates between the two voltage values, with the rate of change dependent upon both the wave shape and the frequency.
- ▶ **Frequency:** The rate at which full waveform cycles occur. Frequency is measured in Hertz (Hz), formerly known as cycles per second. Frequency is inversely related to the period (or wavelength) of the waveform, which is a measure of the distance between two similar peaks on adjacent waves. Higher frequencies have shorter periods.
- ▶ **Phase:** In theory, the placement of a waveform cycle relative to a 0 degree point. In practice, phase is the time placement of a cycle relative to a reference waveform or point in time.

Phase is best explained by looking at a sine wave. The voltage level of sine waves is mathematically related to circular motion. Like a full circle, one

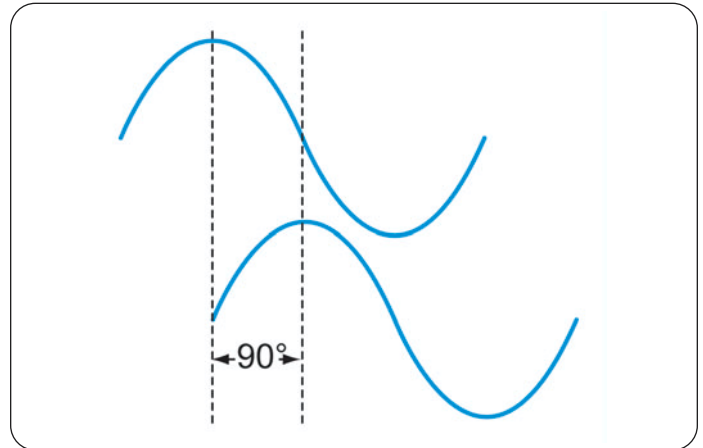

▶ **Figure 4.** Phase shift (also known as delay), describes the difference in timing between two signals. Phase is usually expressed in degrees as shown, but a time value may be more appropriate in some circumstances.

cycle of a sine wave travels through 360 degrees. The phase angle of a sine wave describes how much of its period has elapsed.

Two waveforms may have identical frequency and amplitude and still differ in phase. Phase shift, also known as delay, describes the difference in timing between two otherwise similar signals, as shown in Figure 4. Phase shifts are common in electronics.

The amplitude, frequency, and phase characteristics of a waveform are the building blocks a signal source uses to optimize waveforms for almost any application. In addition, there are other parameters that further define signals, and these too are implemented as controlled variables in many signal sources.

Rise and Fall Time

Rise and fall time, characteristics usually ascribed to pulses and square waves, are measures of the time it takes the signal edge to make a transition from one state to another. In modern digital circuitry, these values are usually in the low nanosecond range or less.

Both rise and fall times are measured between the 10% and 90% points of the static voltage levels before and after the transition (20% and 80% points are sometimes used as alternatives). Figure 5 illustrates a pulse and some of the characteristics associated with it. This is an image of the type you would see on an oscilloscope set at a high sample rate relative to the frequency of the incoming signal. At a lower sample rate, this same waveform would look much more “square.”

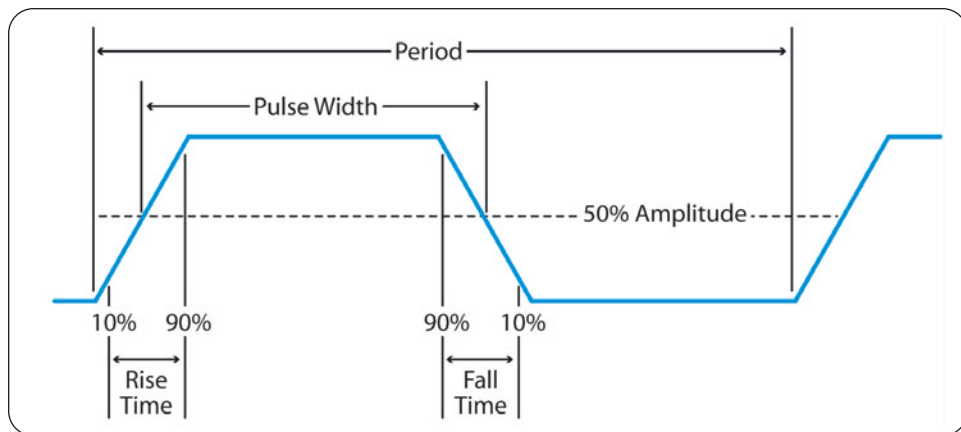

▶ **Figure 5.** Basic pulse characteristics.

Pulse Width

Pulse width is the time that elapses between the leading and trailing edges of a pulse. Note that the term “leading” applies to either positive-going or negative-going edges as does the term “trailing.” In other words, these terms denote the order in which the events occur during a given cycle; a pulse’s polarity does not affect its status as the leading or trailing edge. In Figure 5, the positive-going edge is the leading edge. The pulse width measurement expressed the time between the 50% amplitude points of the respective edges.

Another term, “duty cycle,” is used to describe a pulse’s high and low (on/off) time intervals. The example in Figure 5 represents a 50% duty cycle. In contrast, a cycle with a period of 100 ns whose active high (on) level lasts 60 ns is said to have a 60% duty cycle.

To cite a tangible example of a duty cycle, imagine an actuator that must rest for three seconds after each one-second burst of activity, in order to prevent the motor from overheating. The actuator rests for three seconds out of every four – a 25% duty cycle.

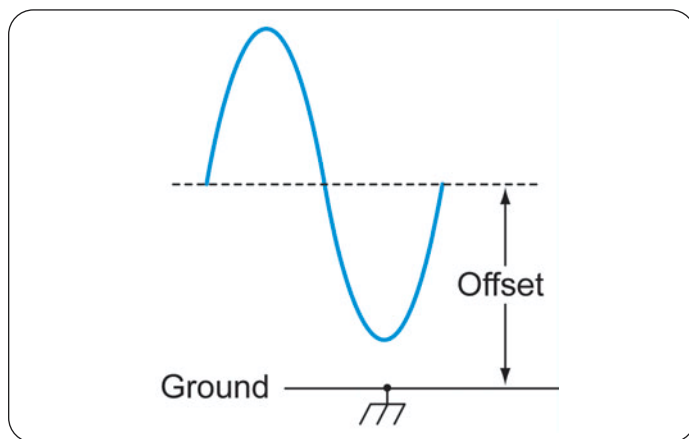

▶ **Figure 6.** The offset voltage describes the DC component of a signal containing both AC and DC values.

XYZs of Signal Sources

▶ Primer

Offset

Not all signals have their amplitude variations centered on a ground (0 V) reference. The “offset” voltage is the voltage between circuit ground and the center of the signal’s amplitude. In effect, the offset voltage expresses the DC component of a signal containing both AC and DC values, as shown in Figure 6.

Differential vs. Single-ended Signals

Differential signals are those that use two complementary paths carrying copies of the same signal in equal and opposite polarity (relative to ground). As the signal’s cycle proceeds and the one path becomes more positive, the other becomes more negative to the same degree. For example, if the signal’s value at some instant in time was +1.5 volts on one of the paths, then the value on the other path would be exactly -1.5 volts (assuming the two signals were perfectly in phase). The differential architecture is good at rejecting crosstalk and noise and passing only the valid signal.

Single-ended operation is a more common architecture, in which there is only one path plus ground. Figure 7 illustrates both single-ended and differential approaches.

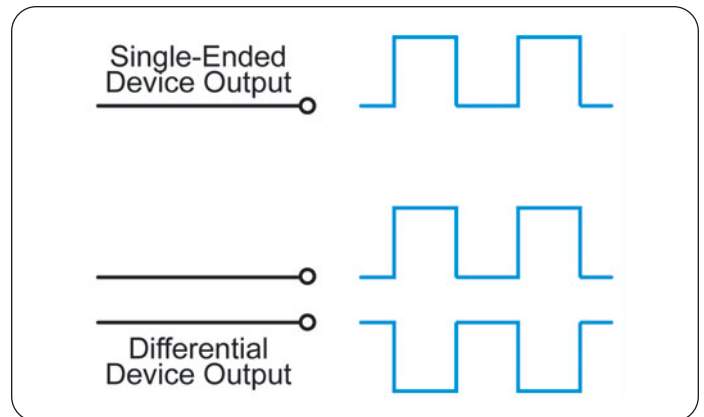

▶ **Figure 7.** Single-ended and differential signals.

Basic Waves

Waveforms come in many shapes and forms. Most electronic measurements use one or more of the following wave shapes, often with noise or distortion added:

- ▶ Sine waves
- ▶ Square and rectangular waves
- ▶ Sawtooth and triangle waves
- ▶ Step and pulse shapes
- ▶ Complex waves

Sine Waves

Sine waves are perhaps the most recognizable wave shape. Most AC power sources produce sine waves. Household wall outlets deliver power in the form of sine waves. And the sine wave is almost always used in elementary classroom demonstrations of electrical and electronic principles. The sine wave is the result of a basic mathematical function – graphing a sine curve through 360 degrees will produce a definitive sine wave image.

The damped sine wave is a special case in which a circuit oscillates from an impulse, and then winds down over time.

Many applications such as frequency response tests call for a “swept” sine wave – one that increases in frequency over some period of time. In effect, this is a form of frequency modulation.

Figure 8 shows examples of sine and damped sine wave-derived signals.

Square And Rectangular Waves

Square and rectangular waves are basic forms that are at the heart of all digital electronics, and they have other uses as well. A square wave is a voltage that switches between two fixed voltage levels at equal intervals. It is routinely used to test amplifiers, which should be able to reproduce the

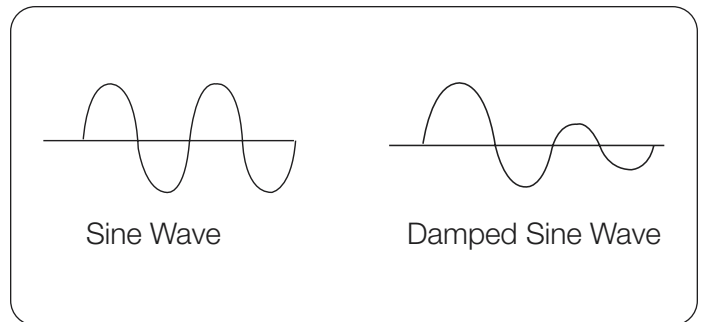

▶ **Figure 8.** Sine and damped sine waves.

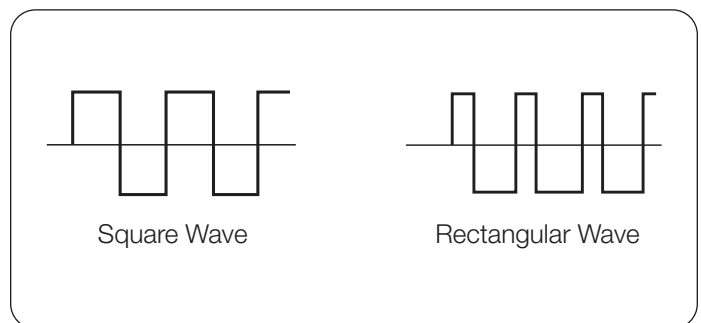

▶ **Figure 9.** Square and rectangular waves.

fast transitions between the two voltage levels (these are the rise and fall times explained earlier). The square wave makes an ideal timekeeping clock for digital systems – computers, wireless telecom equipment, HDTV systems, and more.

A rectangular wave has switching characteristics similar to those of a square wave, except that its high and low time intervals are not of equal length, as described in the earlier “duty cycle” explanation. Figure 9 shows examples of square and rectangular waves.

XYZs of Signal Sources

▶ Primer

Sawtooth and Triangle Waves

Sawtooth and triangle waves look very much like the geometric shapes they are named for. The sawtooth ramps up slowly and evenly to a peak in each cycle, then falls off quickly. The triangle has more symmetrical rise and fall times. These waveforms are often used to control other voltages in systems such as analog oscilloscopes and televisions. Figure 10 shows examples of sawtooth and triangle waves.

Step and Pulse Shapes

A “step” is simply a waveform that shows a sudden change in voltage, as though a power switch had been turned on.

The “pulse” is related to the rectangular wave. Like the rectangle, it is produced by switching up and then down, or down and then up, between two fixed voltage levels. Pulses are inherently binary and therefore are the basic tool for carrying information (data) in digital systems. A pulse might represent one bit of information traveling through a computer. A collection of pulses traveling together creates a pulse train. A synchronized group of pulse trains (which may be transmitted in parallel or serial fashion) makes up a digital pattern. Figure 11 shows examples of step and pulse shapes and a pulse train.

Note that, while digital data is nominally made up of pulses, rectangles, and square waves, real-world digital waveforms exhibit more rounded corners and slanted edges.

Sometimes, circuit anomalies produce pulses spontaneously. Usually these transient signals occur non-periodically, and have come to be described

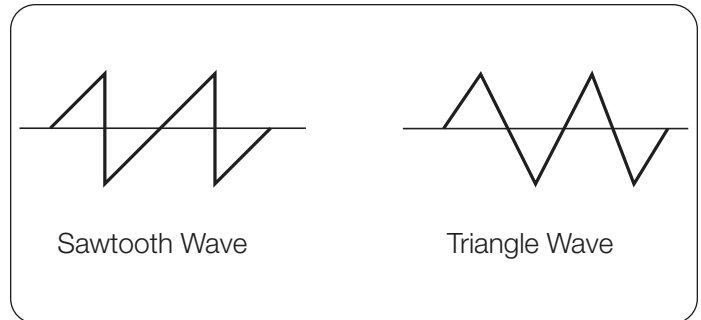

▶ **Figure 10.** Sawtooth and triangle waves.

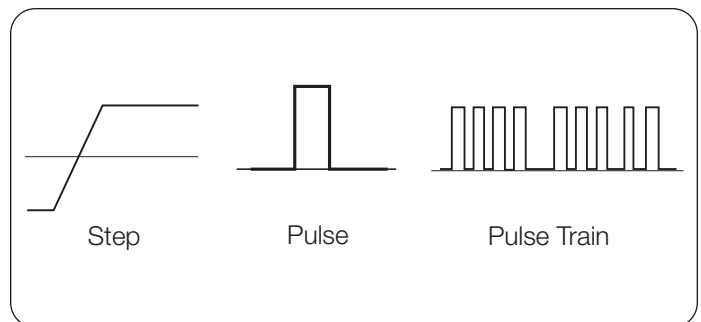

▶ **Figure 11.** Step, pulse, and pulse train shapes.

with the term “glitch.” One of the challenges of digital troubleshooting is distinguishing glitch pulses from valid but narrow data pulses. And one of the strengths of certain types of signal sources is their ability to add glitches anywhere in a pulse train.

Complex Waves

In operational electronic systems, waveforms rarely look like the textbook examples explained above. Certain clock and carrier signals are pure, but most other waveforms will exhibit some unintended distortion (a by-product of circuit realities like distributed capacitance, crosstalk, and more) or deliberate modulation. Some waveforms may even include elements of sines, squares, steps, and pulses.

Complex waves include:

- ▶ Analog modulated, digitally modulated, pulse-width modulated, and quadrature modulated signals
- ▶ Digital patterns and formats
- ▶ Pseudo-random bit and word streams

Signal Modulation

In modulated signals, amplitude, phase and/or frequency variations embed lower-frequency information into a carrier signal of higher frequency. The resulting signals may convey anything from speech to data to video. The waveforms can be a challenge to reproduce unless the signal source is specifically equipped to do so.

Analog Modulation. Amplitude modulation (AM) and frequency modulation (FM) are most commonly used in broadcast communications. The modulating signal varies the carrier's amplitude and/or frequency. At the receiving end, demodulating circuits interpret the amplitude and/or frequency variations, and extract the content from the carrier.

Phase modulation (PM) modulates the phase rather than the frequency of the carrier waveform to embed the content.

Figure 12 illustrates an example of analog modulation.

Digital Modulation. Digital modulation, like other digital technologies, is based on two states which allow the signal to express binary data. In amplitude-shift keying (ASK), the digital modulating signal causes the output frequency to switch between two amplitudes; in frequency-shift keying (FSK), the carrier switches between two frequencies (its center frequency and an offset frequency); and in phase-shift keying (PSK), the carrier switches between two phase settings. In PSK, a "0" is imparted by sending

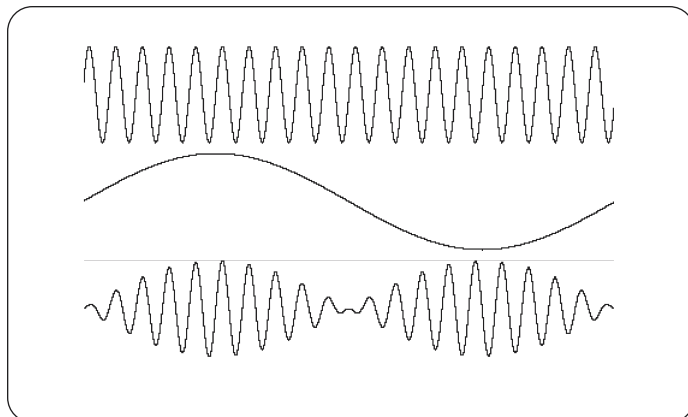

▶ **Figure 12.** Amplitude modulation.

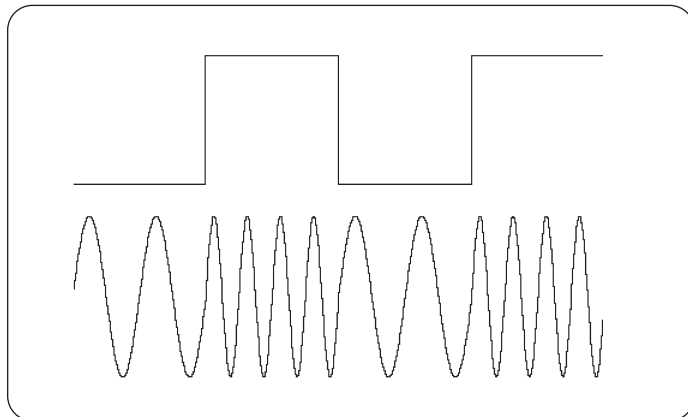

▶ **Figure 13.** Frequency-shift keying (FSK) Modulation.

a signal of the same phase as the previous signal, while a "1" bit is represented by sending a signal of the opposite phase.

Pulse-width modulation (PWM) is yet another common digital format; it is often used in digital audio systems. As its name implies, it is applicable to pulse waveforms only. With PWM, the modulating signal causes the active pulse width (duty cycle, explained earlier) of the pulse to vary.

Figure 13 shows an example of digital modulation.

XYZs of Signal Sources

▶ Primer

Quadrature Modulation. Today's digital wireless communications networks are built on a foundation of quadrature (IQ) modulation technology. Two carriers – an in-phase (I) waveform and a quadrature-phase (Q) waveform that is delayed by exactly 90 degrees relative to the “I” waveform – are modulated to produce four states of information. The two carriers are combined and transmitted over one channel, then separated and demodulated at the receiving end. The IQ format delivers far more information than other forms of analog and digital modulation: it increases the effective bandwidth of the system. Figure 14 depicts quadrature modulation.

Digital Patterns and Formats

A digital pattern consists of multiple synchronized pulse streams that make up “words” of data that may be 8, 12, 16, or more bits wide. One class of signal source, the digital pattern generator, specializes in delivering words of data to digital buses and processors via parallel outputs. The words in these patterns are transmitted in a steady march of cycles, with the activity for each bit in each cycle determined by the chosen signal format. The formats affect the width of the pulses within the cycles that compose the data streams.

The following list summarizes the most common formats. The first three format explanations assume that the cycle begins with a binary “0” value – that is, a low logic voltage level.

- ▶ **Non-Return-to-Zero (NRZ):** When a valid bit occurs in the cycle, the waveform switches to a “1” and stays at that value until the next cycle boundary.
- ▶ **Delayed Non-Return-to-Zero (DNRZ):** Similar to NRZ, except that the waveform switches to a “1” after a specified delay time.
- ▶ **Return-to-Zero (RZ):** When a valid bit is present, the waveform switches to a “1,” then back to a “0” within the same cycle.
- ▶ **Return-to-One (R1):** In effect, the inverse of RZ. Unlike the other formats in this list, R1 assumes the cycle begins with a “1”, then switches to a “0” when the bit is valid, then switches back to a “1” before the cycle ends.

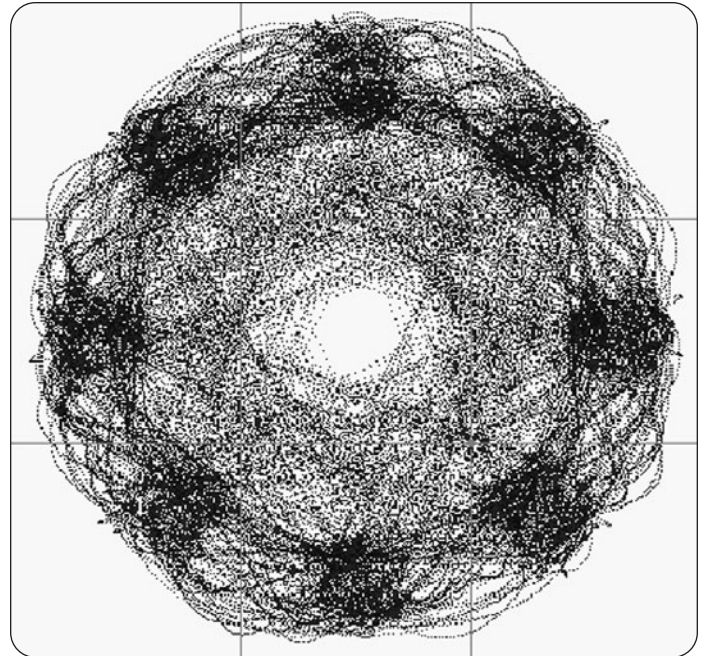

▶ **Figure 14.** Quadrature modulation.

Bit Streams

Pseudo-random bit streams (PRBS) and pseudo-random word streams (PRWS) exist to make up for an innate limitation in digital computers: their inability to produce truly random numbers. Yet random events can have beneficial uses in digital systems. For example, perfectly “clean” digital video signals may have objectionable jagged lines and noticeable contours on surfaces that should be smooth. Adding a controlled amount of noise can hide these artifacts from the eye without compromising the underlying information.

To create random noise, digital systems produce a stream of numbers that has the effect of randomness even though the numbers follow a predictable mathematical pattern. These “pseudo-random” numbers are actually a set of sequences repeated at a random rate. The result is a PRBS. A pseudo-random word stream defines how multiple PRBS streams are presented across the signal source's parallel outputs.

PRWS is often used when testing serializers or multiplexers. These elements reassemble the PRWS signal into a serial stream of pseudo-random bits.

▶ **Types of Signal Sources**

Broadly divided into mixed signal sources (arbitrary waveform generators and arbitrary function generators) and logic sources (pulse or pattern generators), signal sources span the whole range of signal-producing needs. Each of these types has unique strengths that may make it more or less suitable for specific applications.

Mixed signal sources are designed to output waveforms with analog characteristics. These may range from analog waves such as sines and triangles to “square” waves that exhibit the rounding and imperfections that are part of every real-world signal. In a versatile mixed signal source, you can control amplitude, frequency, and phase as well as DC offset and rise and fall time; you can create aberrations such as overshoot; and you can add edge jitter, modulation, and more.

True digital sources are meant to drive digital systems. Their outputs are binary pulse streams – a dedicated digital source cannot produce a sine or triangle wave. The features of a digital source are optimized for computer bus needs and similar applications. These features might include software tools to speed pattern development as well as hardware tools such as probes designed to match various logic families.

As explained earlier, almost all high-performance signal sources today, from function generators to arbitrary sources to pattern generators, are based on digital architectures, allowing flexible programmability and exceptional accuracy.

XYZs of Signal Sources

▶ Primer

▶ Analog and Mixed Signal Sources

Types of Analog and Mixed Signal Sources

Arbitrary Generators

Historically, the task of producing diverse waveforms has been filled by separate, dedicated signal sources, from ultra-pure audio sine wave generators to multi-GHz RF signal generators. While there are many commercial solutions, the user often must custom-design or modify a signal source for the project at hand. It can be very difficult to design an instrumentation-quality signal generator, and of course, the time spent designing ancillary test equipment is a costly distraction from the project itself.

Fortunately, digital sampling technology and signal processing techniques have brought us a solution that answers almost any kind of signal generation need with just one type of instrument – the arbitrary generator.

Arbitrary generators can be classified into arbitrary function generators (AFG) and arbitrary waveform generators (AWG).

Arbitrary Function Generator (AFG)

The arbitrary function generator (AFG) serves a wide range of stimulus needs; in fact, it is the prevailing signal source architecture in the industry today. Typically, this instrument offers fewer waveform variations than its AWG equivalent, but with excellent stability and fast response to frequency changes. If the DUT requires the classic sine and square waveforms (to name a few) and the ability to switch almost instantly between two frequencies, the arbitrary function generator (AFG) is the right tool. An additional virtue is the AFG's low cost, which makes it very attractive for applications that do not require an AWG's versatility.

The AFG shares many features with the AWG, although the AFG is by design a more specialized instrument. The AFG offers unique strengths: it produces stable waveforms in standard shapes – particularly the all-important sine and square waves – that are both accurate and agile. Agility is the ability to change quickly and cleanly from one frequency to another.

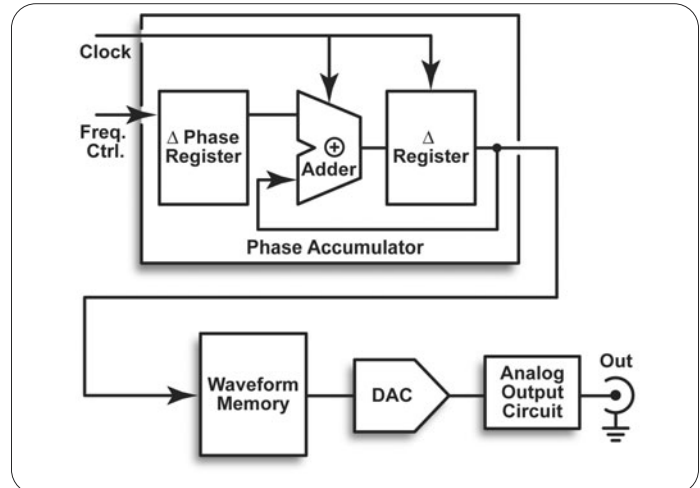

▶ **Figure 15.** The architecture of an arbitrary function generator (simplified).

Most AFGs offer some subset of the following familiar wave shapes:

- ▶ Sine
- ▶ Square
- ▶ Triangle
- ▶ Sweep
- ▶ Pulse
- ▶ Ramp
- ▶ Modulation
- ▶ Haversine

While AWGs can certainly provide these same waveforms, today's AFGs are designed to provide improved phase, frequency, and amplitude control of the output signal. Moreover, many AFGs offer a way to modulate the signal from internal or external sources, which is essential for some types of standards compliance testing.

In the past, AFGs created their output signals using analog oscillators and signal conditioning. More recent AFGs rely on Direct Digital Synthesis (DDS) techniques to determine the rate at which samples are clocked out of their memory.

DDS technology synthesizes waveforms by using a single clock frequency to spawn any frequency within the instrument's range. Figure 15 summarizes the DDS-based AFG architecture in simplified form.

In the phase accumulator circuit, the Delta (Δ) phase register receives instructions from a frequency controller, expressing the phase increments by which the output signal will advance in each successive cycle. In a modern high-performance AFG, the phase resolution may be as small as one part in 2^{30} , that is, approximately 1/1,000,000,000.

The output of the phase accumulator serves as the clock for the waveform memory portion of the AFG. The instrument's operation is almost the same as that of the AWG, with the notable exception that the waveform memory typically contains just a few basic signals such as sine and square waves. The analog output circuit is basically a fixed-frequency, low-pass filter which ensures that only the programmed frequency of interest (and no clock artifacts) leaves the AFG output.

To understand how the phase accumulator creates a frequency, imagine that the controller sends a value of 1 to the 30-bit Δ phase register. The phase accumulator's Δ output register will advance by $360 \div 2^{30}$ in each cycle, since 360 degrees represents a full cycle of the instrument's output waveform. Therefore, a Δ phase register value of 1 produces the lowest frequency waveform in the AFG's range, requiring the full 2Δ increments to create one cycle. The circuit will remain at this frequency until a new value is loaded into the Δ phase register.

Values greater than 1 will advance through the 360 degrees more quickly, producing a higher output frequency (some AFGs use a different approach: they increase the output frequency by skipping some samples, thereby reading the memory content faster). The only thing that changes is the phase value supplied by the frequency controller. The main clock frequency does not need to change at all. In addition, it allows a waveform to commence from any point in the waveform cycle.

For example, assume it is necessary to produce a sine wave that begins at the peak of the positive-going part of the cycle. Basic math tells us that this peak occurs at 90 degrees. Therefore:

$$2^{30} \text{ increments} = 360^\circ; \text{ and}$$

$$90^\circ = 360^\circ \div 4; \text{ then,}$$

$$90^\circ = 2^{30} \div 4$$

When the phase accumulator receives a value equivalent to $(2^{30} \div 4)$, it will prompt the waveform memory to start from a location containing the positive peak voltage of the sine wave.

The typical AFG has just a few types of waveforms stored in its memory. In general, sine and square waves are the most widely used for many test applications. Some AFGs are hybrid units that deliver accurate, agile DDS-based sine and square waves, while other wave shapes are created using more conventional AWG techniques. This is a cost-effective solution that puts the highest performance behind the most critical functions.

DDS architecture provides exceptional frequency agility, making it easy to program both frequency and phase changes on the fly, which is useful to test any type of FM DUT – radio and satellite system components, for example. And if the specific AFG's frequency range is sufficient, it's an ideal signal source for test on FSK and frequency-hopping telephony technologies such as GSM.

Although it cannot equal the AWG's ability to create virtually any imaginable waveform, the AFG produces the most common test signals used in labs, repair facilities and design departments around the world. Moreover, it delivers excellent frequency agility. And importantly, the AFG is often a very cost-effective way to get the job done.

Arbitrary Waveform Generator (AWG)

Whether you want a data stream shaped by a precise Lorentzian pulse for disk drive characterization, or a complex modulated RF signal to test a GSM- or CDMA-based telephone handset, the arbitrary waveform generator (AWG) can produce any waveform you can imagine. You can use a variety of methods – from mathematical formulae to “drawing” the waveform – to create the needed output.

XYZs of Signal Sources

▶ Primer

Fundamentally, an arbitrary waveform generator (AWG) is a sophisticated playback system that delivers waveforms based on stored digital data that describes the constantly changing voltage levels of an AC signal. It is a tool whose block diagram is deceptively simple. To put the AWG concept in familiar terms, it is much like a CD player that reads out stored data (in the AWG, its own waveform memory; in the CD player, the disc itself) in real time. Both put out an analog signal, or waveform.

To understand the AWG, it's first necessary to grasp the broad concepts of digital sampling. Digital sampling is exactly what its name implies: defining a signal using samples, or data points, that represent a series of voltage measurements along the slope of the waveform. These samples may be determined by actually measuring a waveform with an instrument such as an oscilloscope, or by using graphical or mathematical techniques. Figure 16 (Top) depicts a series of sampled points. All of the points are sampled at uniform time intervals, even though the curve makes their spacing appear to vary. In an AWG, the sampled values are stored in binary form in a fast Random Access Memory (RAM).

With the stored information, the signal can be reconstructed (bottom) at any time by reading back the memory locations and feeding the data points through a digital-to-analog converter (DAC). Figure 16 (Bottom) depicts the result. Note that the AWG's output circuitry filters between the points to connect the dots and create a clean, uninterrupted waveform shape. The DUT does not "see" these dots as discrete points, but as a continuous analog waveform.

Figure 17 is a simplified block diagram of an AWG that implements these operations.

The AWG offers a degree of versatility that few instruments can match. With its ability to produce any waveform imaginable, the AWG embraces applications ranging from automotive anti-lock brake system simulation to wireless network stress testing.

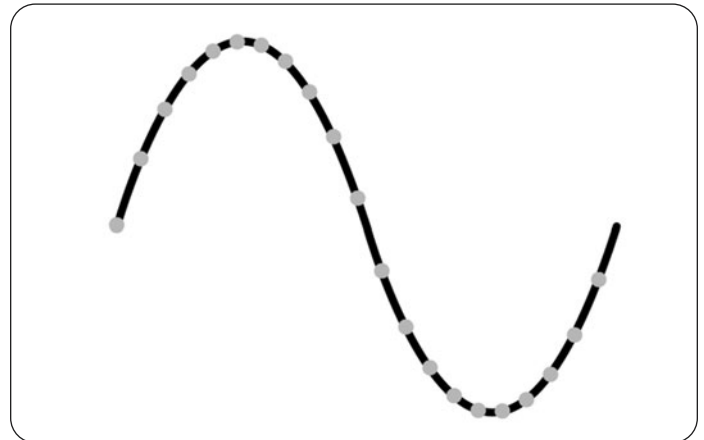
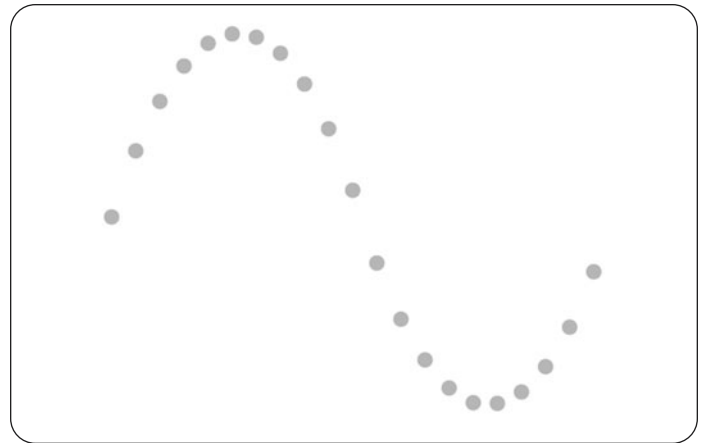

▶ **Figure 16.** (Top) A series of sampled points representing a sine wave; (Bottom) the reconstructed sine wave.

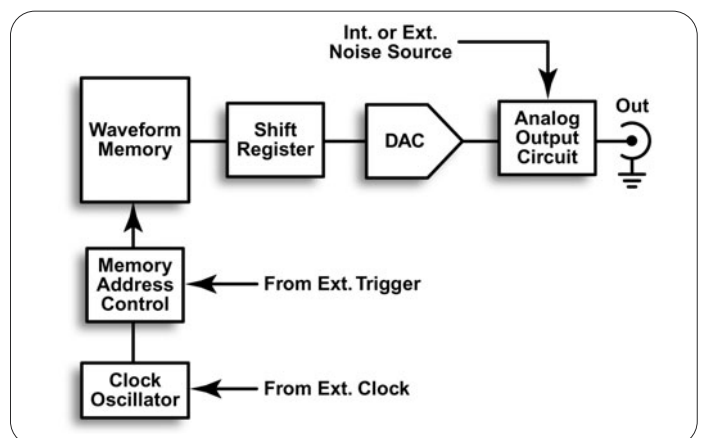

▶ **Figure 17.** The architecture of an arbitrary waveform generator (simplified).

The Systems and Controls of a Mixed Signal Source

Consistent with its role as the stimulus element of a complete measurement solution, the mixed-signal source’s controls and sub-systems are designed to speed the development of a wide range of waveform types, and to deliver the waveforms with uncompromised fidelity.

The most basic and frequently-manipulated signal parameters have their own dedicated front-panel controls. More complex operations and those that are needed less frequently are accessed via menus on the instrument’s display screen.

The **Vertical System** is responsible for setting the amplitude and offset level of the output signal. In the signal source depicted in Figure 18, the dedicated vertical controls on the front panel make it easy to set amplitude and offset values without relying on multi-level menus.

The **Horizontal System** sets the frequency of the output signal by controlling the sample rate. Here, too, dedicated hardware-based controls simplify setup of the essential horizontal parameters.

The **Trigger System** defines the conditions under which the instrument will commence driving signals through its output, assuming it is not running in a continuous mode.

Note that none of the parameters above control the actual wave shape that the instrument produces. This functionality resides in menus on the **Editing/Control Screen**. “Soft” **Menu Buttons** surrounding the screen select the view of interest, which might offer controls to define sequences, or rise/fall times, or application-specific features as shown in Figure 19, a control page for hard disk drive signals. After bringing up such a page, you simply fill in the blanks using the numerical keypad and/or the general-purpose scrolling knob.

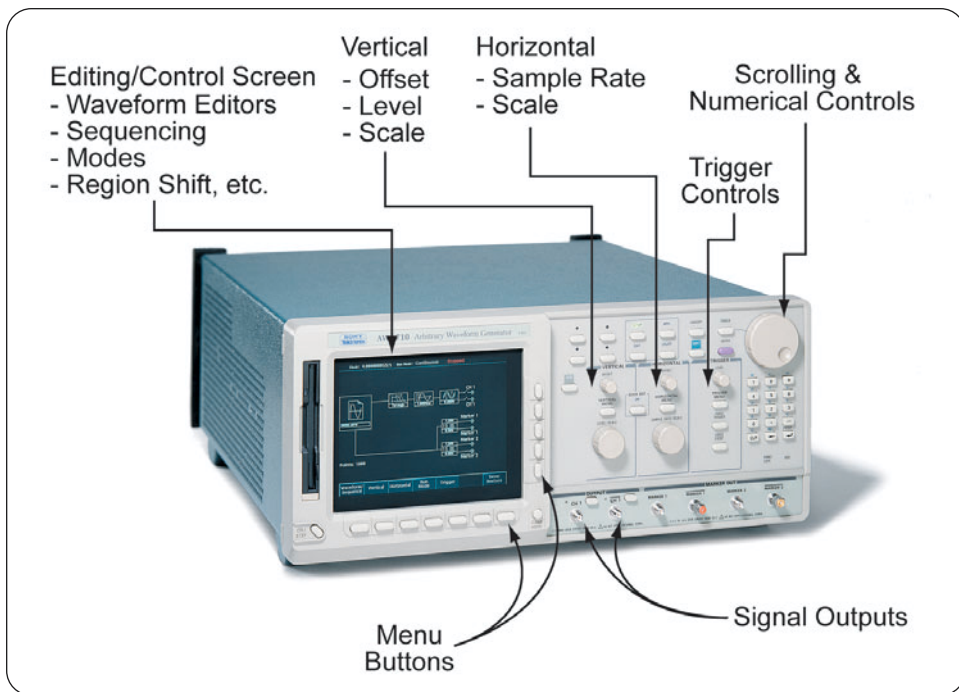

► **Figure 18.** A high-performance mixed signal source: the Tektronix AWG710 Arbitrary Waveform Generator.

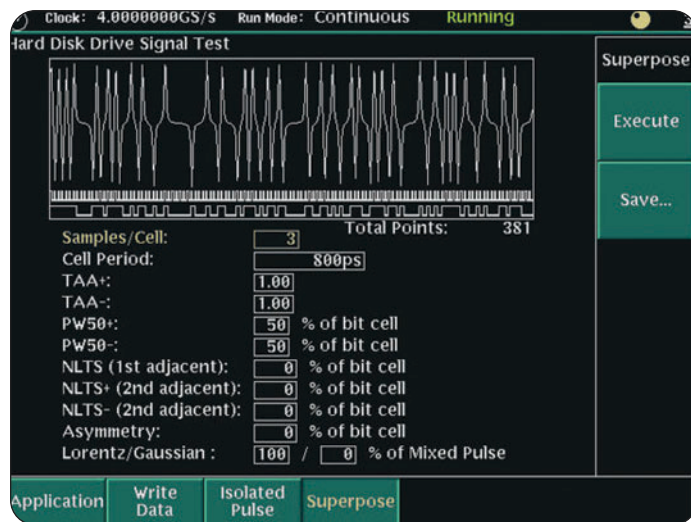

► **Figure 19.** AWG user interface showing soft keys and menu choices.

XYZs of Signal Sources

▶ Primer

Performance Terms and Considerations

Following are some definitions of parameters that describe the performance of a mixed signal source. You will see these terms used in brochures, reference books, tutorials... almost anywhere signal sources or their applications are described.

Memory Depth (Record Length)

Memory depth, or record length, goes hand-in-hand with clock frequency. Memory depth determines the maximum number of samples that can be stored. Every waveform sample point occupies a memory location. Each location equates to a sample interval's worth of time at the current clock frequency. If the clock is running at 100 MHz, for example, the stored samples are separated by 10 ns.

Memory depth plays an important role in signal fidelity at many frequencies because it determines how many points of data can be stored to define a waveform. Particularly in the case of complex waveforms, memory depth is critical to reproducing signal details accurately. The benefits of increased memory depth can be summarized as follows:

- ▶ More cycles of the desired waveform can be stored, and memory depth, in combination with the signal source's sequencing capability, allows the instrument to flexibly join together different waveforms to create infinite loops, patterns, and the like.
- ▶ More waveform detail can be stored. Complex waveforms can have high-frequency information in their pulse edges and transients. It is difficult to interpolate these fast transitions. To faithfully reproduce a complex signal, the available waveform memory capacity can be used to store more transitions and fluctuations rather than more cycles of the signal.

High-performance mixed signal sources offer deep memory depth and high sample rates. These instruments can store and reproduce complex waveforms such as pseudo-random bit streams. Similarly, these fast sources with deep memory can generate very brief digital pulses and transients.

Sample (Clock) Rate

Sample rate, usually specified in terms of megasamples or gigasamples per second, denotes the maximum clock or sample rate at which the instrument can operate. The sample rate affects the frequency and fidelity of the main output signal. The Nyquist Sampling Theorem states that the

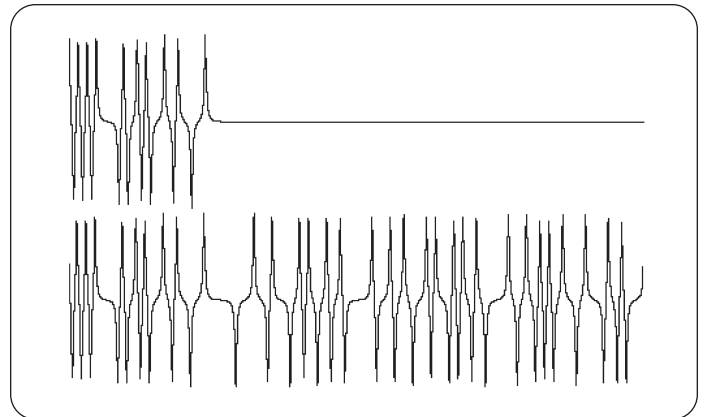

▶ **Figure 20.** With sufficient memory depth, the arbitrary signal source can reproduce extremely complex wave shapes.

sampling frequency, or clock rate, must be more than twice that of the highest spectral frequency component of the generated signal to ensure accurate signal reproduction. To generate a 1 MHz sine wave signal, for instance, it is necessary to produce sample points at a frequency of more than 2 megasamples per second (MS/s). Although the theorem is usually cited as a guideline for acquisition, as with an oscilloscope, its pertinence to signal sources is clear: stored waveforms must have enough points to faithfully retrace the details of the desired signal.

The signal source can take these points and read them out of memory at any frequency within its specified limits. If a set of stored points conforms to the Nyquist Theorem and describes a sine wave, then the signal source will filter the waveform appropriately and output a sine wave.

Calculating the frequency of the waveform that the signal source can produce is a matter of solving a few simple equations. Consider the example of an instrument with one waveform cycle stored in memory:

Given a 100 MS/s clock frequency and a memory depth, or record length, of 4000 samples,

Then:

$$F_{\text{output}} = \text{Clock Frequency} \div \text{Memory Depth}$$

$$F_{\text{output}} = 100,000,000 \div 4000$$

$$F_{\text{output}} = 25,000 \text{ Hz (or 25 kHz)}$$

Figure 21 illustrates this concept.

At the stated clock frequency, the samples are about 10 ns apart. This is the time resolution (horizontal) of the waveform. Be sure not to confuse this with the amplitude resolution (vertical).

Carrying this process a step further, assume that the sample RAM contains not one, but four cycles of the waveform:

$$F_{\text{output}} = (\text{Clock Frequency} \div \text{Memory Depth}) \times (\text{cycles in memory})$$

$$F_{\text{output}} = (100,000,000 \div 4000) \times (4)$$

$$F_{\text{output}} = (25,000 \text{ Hz}) \times (4)$$

$$F_{\text{output}} = 100,000 \text{ Hz}$$

The new frequency is 100 kHz. Figure 22 depicts this concept.

In this instance, the time resolution of each waveform cycle is lower than that of the single-waveform example – in fact, it is exactly four times lower. Each sample now represents 40 ns in time. The increase comes at the cost of some horizontal resolution.

Bandwidth

An instrument's bandwidth is an analog term that exists independently of its sample rate. The analog bandwidth of a signal source's output circuitry must be sufficient to handle the maximum frequency that its sample rate will support. In other words, there must be enough bandwidth to pass the highest frequencies and transition times that can be clocked out of the memory, without degrading the signal characteristics. In Figure 23, an oscilloscope display reveals the importance of adequate bandwidth. The uppermost trace shows the uncompromised rise time of a high-bandwidth source, while the remaining traces depict the degrading effects that result from a lesser output circuit design.

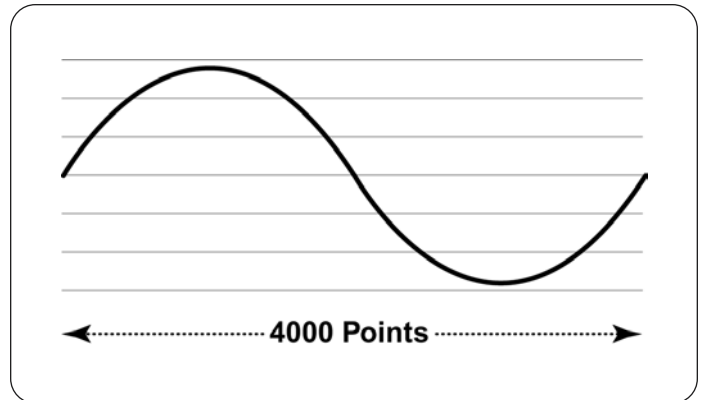

▶ **Figure 21.** At a clock frequency of 100 MHz, the single 4000-point waveform is delivered as a 25 kHz output signal.

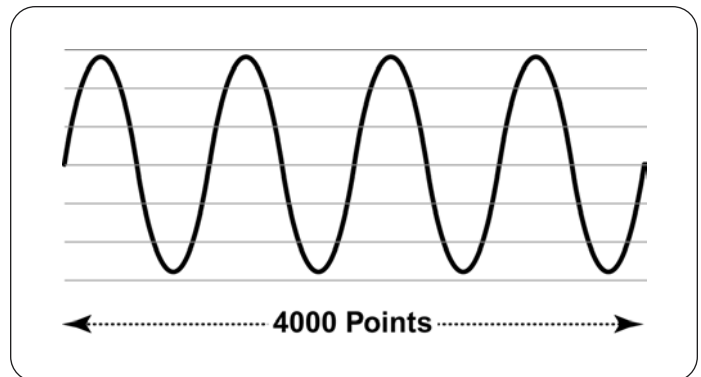

▶ **Figure 22.** Using four stored waveforms and a 100 MHz clock, a 100 kHz signal is produced.

XYZs of Signal Sources

▶ Primer

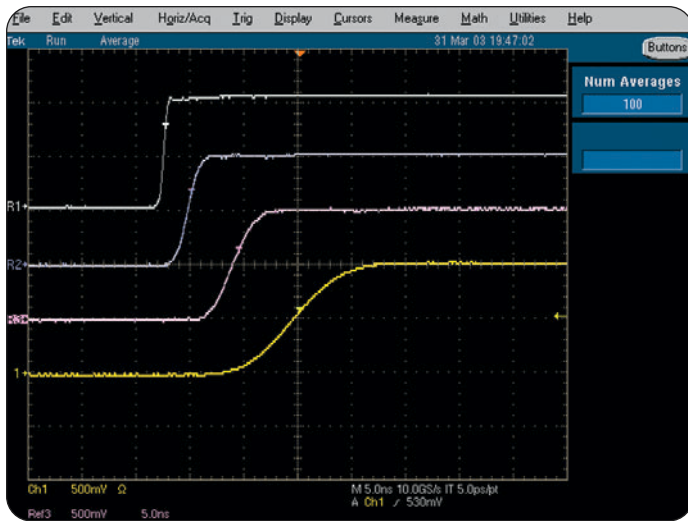

▶ **Figure 23.** Sufficient bandwidth ensures that no signal details are lost.

Vertical (Amplitude) Resolution

In the case of mixed signal sources, vertical resolution pertains to the binary word size, in bits, of the instrument's DAC, with more bits equating to higher resolution. The vertical resolution of the DAC defines the amplitude accuracy and distortion of the reproduced waveform. A DAC with inadequate resolution contributes to quantization errors, causing imperfect waveform generation.

While more is better, in the case of AWGs, higher-frequency instruments usually have lower resolution – 8 or 10 bits – than general-purpose instruments offering 12 or 14 bits. An AWG with 10-bit resolution provides 1024 sample levels spread across the full voltage range of the instrument. If, for example, this 10-bit AWG has a total voltage range of $2 V_{p-p}$, each sample represents a step of approximately 2 mV – the smallest increment the instrument could deliver without additional attenuators, assuming it is not constrained by other factors in its architecture, such as output amplifier gain and offset.

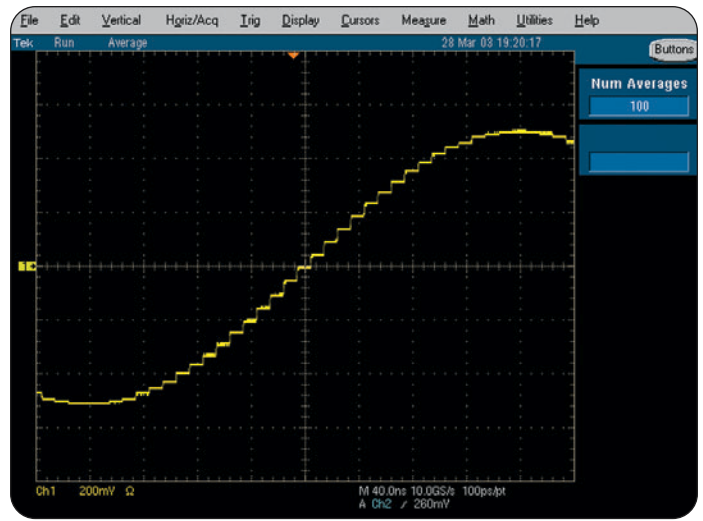

▶ **Figure 24.** (Top) Low vertical resolution; (Bottom) High vertical resolution. Vertical resolution defines the amplitude accuracy of the reproduced waveform.

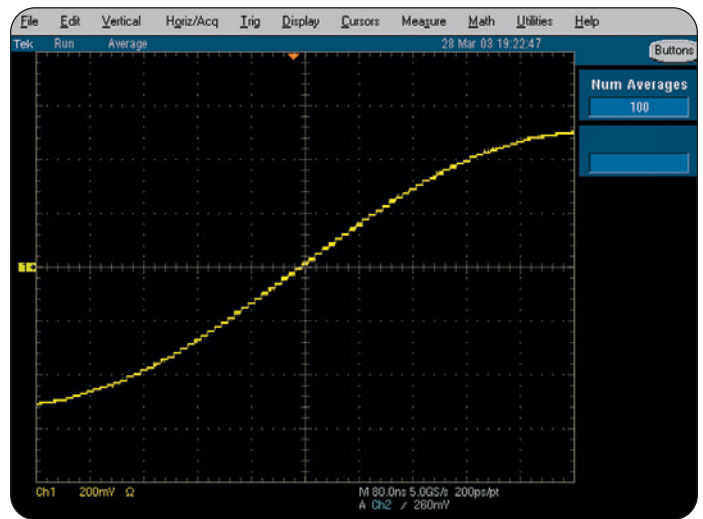

Horizontal (Timing) Resolution

Horizontal resolution expresses the smallest time increment that can be used to create waveforms. Typically this figure is simply the result of the calculation:

$$T = 1/F$$

where T is the timing resolution in seconds and F is the sampling frequency.

By this definition, the timing resolution of a signal source whose maximum clock rate is 100 MHz would be 10 nanoseconds. In other words, the features of the output waveform from this mixed-signal source are defined by a series of steps 10 ns apart.

Some instruments offer tools that significantly extend the effective timing resolution of the output waveform. Although they do not increase the base resolution of the instrument, these tools apply changes to the waveform that reproduce the effect of moving an edge by increments in the picosecond range.

Region Shift

The region shift function shifts a specified edge of a waveform either right or left, toward or away from the programmed center value. If the specified amount of the shift is less than the sampling interval, the original waveform is re-sampled using data interpolation to derive the shifted values.

Region shift makes it possible to create simulated jitter conditions and other tiny edge placement changes that exceed the resolution of the instrument. Again considering the example of a signal source with a 100 MHz clock, it would be meaningless to shift a stimulus edge in 10 ns increments to simulate the effects of jitter. Real-world jitter operates in the low picosecond range. Region shift makes it possible to move the edge by a few picoseconds with each step – a much closer approximation of real jitter phenomenon.

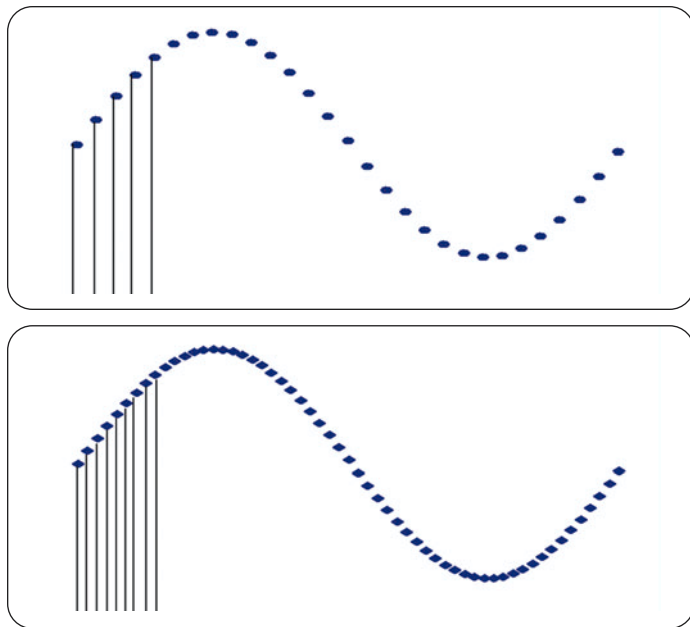

► **Figure 25.** (Top) Low horizontal resolution; (Bottom) High horizontal resolution. Horizontal, or timing, resolution refers to the minimum increment of time by which an edge, cycle time, or pulse width can be changed.

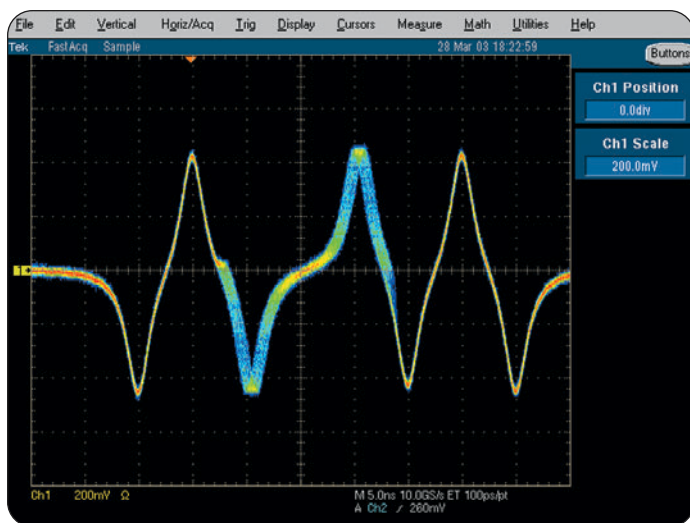

► **Figure 26.** Region shift.

XYZs of Signal Sources

▶ Primer

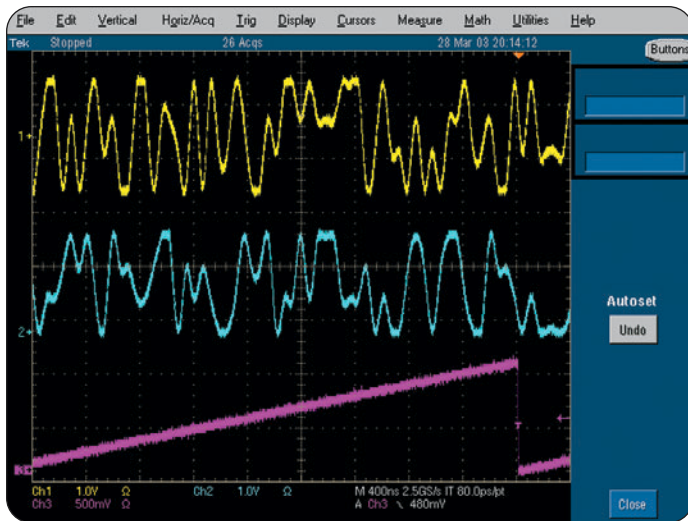

▶ **Figure 27.** Multiple output channels.

Output Channels

Many applications require more than one output channel from the signal source. For example, testing an automotive anti-lock brake system requires four stimulus signals (for obvious reasons). Biophysical research applications call for multiple sources to simulate various electrical signals produced by the human body. And complex IQ-modulated telecommunications equipment requires a separate signal for each of the two phases.

In answer to these needs, a variety of AWG output channel configurations has emerged. Some AWGs can deliver up to four independent channels of full-bandwidth analog stimulus signals. Others offer up to two analog outputs, supplemented by up to 16 high-speed digital outputs for mixed-signal testing. This latter class of tools can address a device's analog, data, and address buses with just one integrated instrument.

Digital Outputs

Some AWGs include separate digital outputs. These outputs fall into two categories: marker outputs and parallel data outputs.

Marker outputs provide a binary signal that is synchronous with the main analog output signal of a signal source. In general, markers allow you to output a pulse (or pulses) synchronized with a specific waveform memory location (sample point). Marker pulses can be used to synchronize the digital portions of a DUT that is at the same time receiving an analog stimulus signal from the mixed-signal source. Equally important, markers can trigger acquisition instruments on the output side of the DUT.

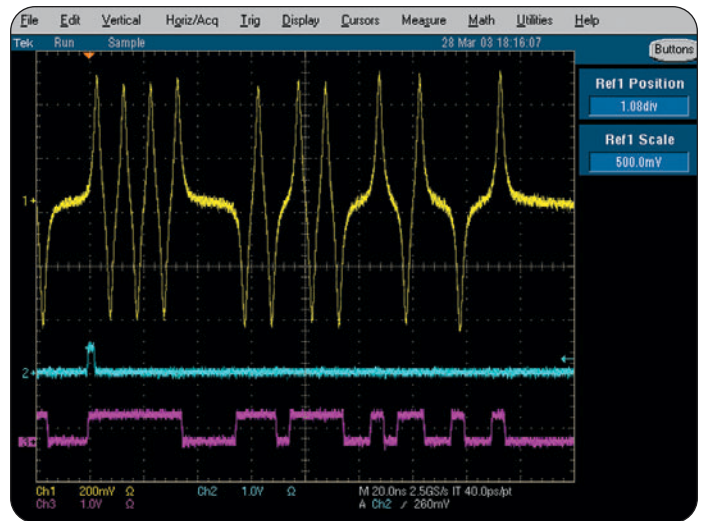

▶ **Figure 28.** Marker outputs.

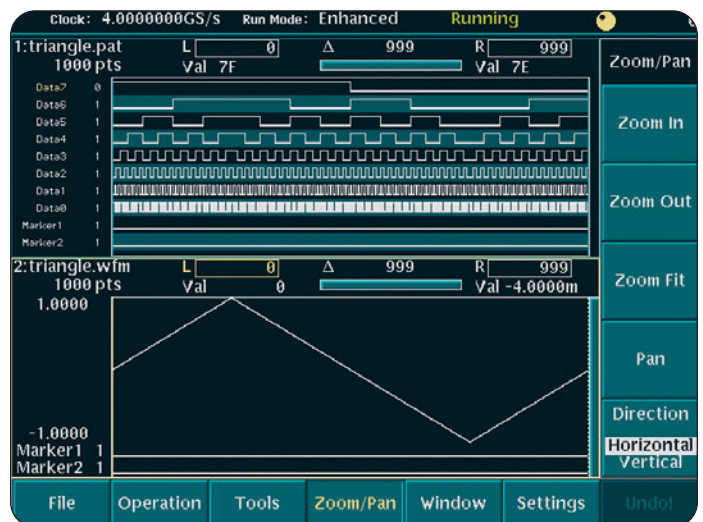

▶ **Figure 29.** Parallel digital outputs.

Marker outputs are typically driven from a memory that is independent of the main waveform memory.

Parallel digital outputs take digital data from the same memory as the source's main analog output. When a particular waveform sample value is present on the analog output, its digital equivalent is available on the parallel digital output. This digital information is ready-made for use as comparison data when testing digital-to-analog converters, among other things. Alternatively, the digital outputs can be programmed independently of the analog output.

Filtering

Once the basic waveform is defined, other operations, such as filtering and sequencing, can be applied to modify or extend it, respectively.

Filtering allows you to remove selected bands of frequency content from the signal. For example, when testing an analog-to-digital converter (ADC), it is necessary to ensure that the analog input signal, which comes from the signal source, is free of frequencies higher than half the converter's clock frequency. This prevents unwanted aliasing distortion in the DUT output, which would otherwise compromise the test results. Aliasing is the intrusion of distorted conversion by-products into the frequency range of interest. A DUT that is putting out an aliased signal cannot produce meaningful measurements.

One reliable way to eliminate these frequencies is to apply a steep low-pass filter to the waveform, allowing frequencies below a specified point to pass through and drastically attenuating those above the cutoff. Filters can also be used to re-shape waveforms such as square and triangle waves. Sometimes it's simpler to modify an existing waveform in this way than to create a new one. In the past, it was necessary to use a signal generator and an external filter to achieve these results. Fortunately, many of today's high-performance signal sources feature built-in filters that can be controlled.

Sequencing

Often, it is necessary to create long waveform files to fully exercise the DUT. Where portions of the waveforms are repeated, a waveform sequencing function can save you a lot of tedious, memory-intensive waveform programming. Sequencing allows you to store a huge number of "virtual" waveform cycles in the instrument's memory. The waveform sequencer borrows instructions from the computer world: loops, jumps, and so forth.

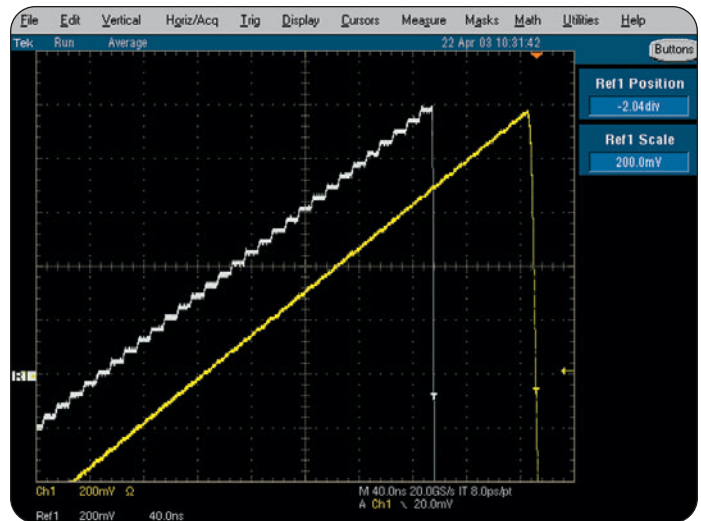

▶ **Figure 30.** Filtering, before and after. Reference 1 (Top) waveform is an unfiltered ramp waveform, while Channel 1 (Bottom) waveform is a filtered ramp waveform.

These instructions, which reside in a sequence memory separate from the waveform memory, cause specified segments of the waveform memory to repeat. Programmable repeat counters, branching on external events, and other control mechanisms determine the number of operational cycles and the order in which they occur. With a sequence controller, you can generate waveforms of almost unlimited length.

To cite a very simple example, imagine that a 4000-point memory is loaded with a clean pulse that takes up half the memory (2000 points), and a distorted pulse that uses the remaining half. If we were limited to basic repetition of the memory content, the signal source would always repeat the two pulses, in order, until commanded to stop. But waveform sequencing changes all that.

XYZs of Signal Sources

▶ Primer

Suppose you wanted the distorted pulse to appear twice in succession after every 511 cycles. You could write a sequence that repeats the clean pulse 511 times, then jumps to the distorted pulse, repeats it twice, and goes back to the beginning to loop through the steps again ... and again. The concept is shown in Figure 31.

Loop repetitions can be set to infinite, to a designated value, or controlled via an external event input. Considering what we have already discussed about the tradeoff between the number of waveform cycles stored and the resulting timing resolution, sequencing provides much-improved flexibility without compromising the resolution of individual waveforms.

Note here that any sequenced waveform segment must continue from the same amplitude point as the segment preceding it. In other words, if a sine wave segment's last sample value was 1.2 volts, the starting value of the next segment in the sequence must be 1.2 volts as well. Otherwise, an undesirable glitch can occur when the DAC attempts to abruptly change to the new value.

Although this example is very basic, it represents the kind of capability that is needed to detect irregular pattern-dependent errors. One example is inter-symbol interference in communications circuits. Inter-symbol interference can occur when a signal's state in one cycle influences the signal in the subsequent cycle, distorting it or even changing its value. With waveform sequencing, it is possible to run long-term stress tests – extending to days or even weeks – with the signal source as a stimulus.

Integrated Editors

Suppose you need a series of waveform segments that have the same shape but different amplitudes as the series proceeds. To create these amplitude variations, you might recalculate the waveform or redraw it using an off-line waveform editor. But both approaches are unnecessarily time-consuming. A better method is to use an integrated editing tool that can modify the waveform memory in both time and amplitude.

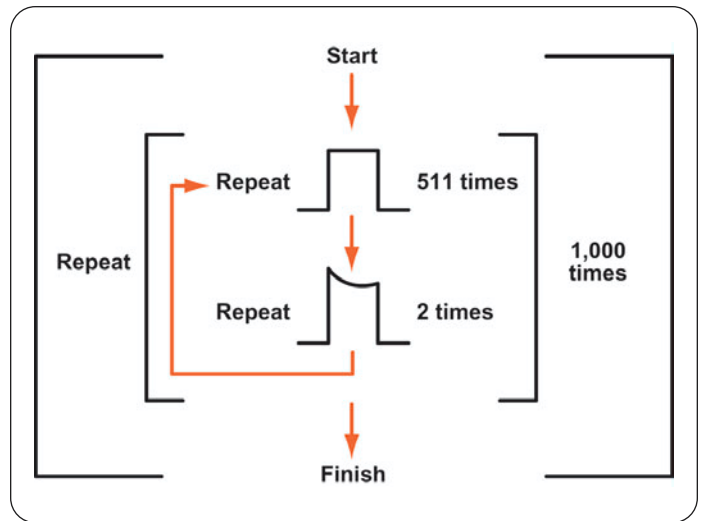

▶ **Figure 31.** The AWG's waveform memory capacity can be expanded with loops and repetitions.

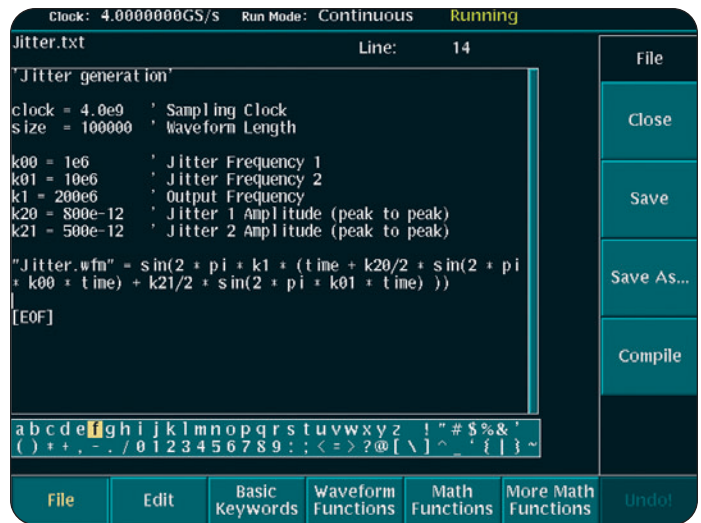

▶ **Figure 32.** The equation editor is just one of several types of integrated editors that permit flexible waveform creation without the use of external tools.

Today's mixed-signal sources offer several types of editing tools to simplify the task of creating waveforms:

- ▶ **Graphic editor** – this tool allows you to construct and view a literal representation of the waveform. The resulting data points are compiled and stored in the waveform memory.
- ▶ **Equation editor** – this is simply a math tool that allows you to enter variables and operators. After checking the syntax, the instrument compiles and stores the resulting waveform.
- ▶ **Sequence editor** – this editor contains computer-like programming constructs (jump, loop, etc.) that operate on stored waveforms specified in the sequence.

Data Import Functions

Data import functions allow you to use waveform files created outside the signal source.

For example, a waveform captured by a modern digital storage oscilloscope can be easily transferred via GPIB or Ethernet to a mixed-signal source. This operation is key to test methodologies in which a reference signal from a “golden device” is used to test all subsequent production copies of that device. The instrument's editing tools are available to manipulate the signal, just like any other stored waveform.

Simulators and other electronic design automation (EDA) tools are another expedient source of waveforms. With the ability to intake, store, and re-create EDA data, the signal source can hasten the development of early design prototypes.

Built-in Applications

In addition to the other built-in waveform development resources, some mixed-signal sources offer optional application-specific signal creation functions. These are, in effect, specialized waveform editors for engineers working with high-speed disk drive or communications equipment. Specific capabilities include generation of Partial Response Maximum Likelihood (PRML) signals with Non-linear Transition Shift (NLTS) characteristics for disk drive development; and generation of 100BaseT or Gigabit Ethernet signals for datacomm applications.

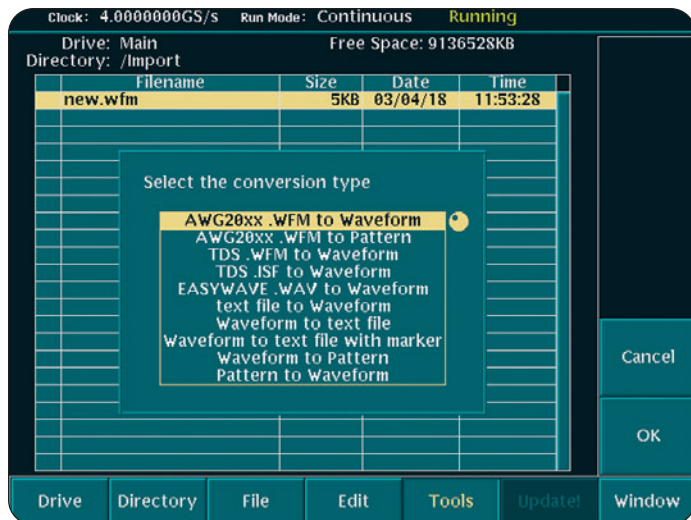

► **Figure 33.** Built-in data communications application.

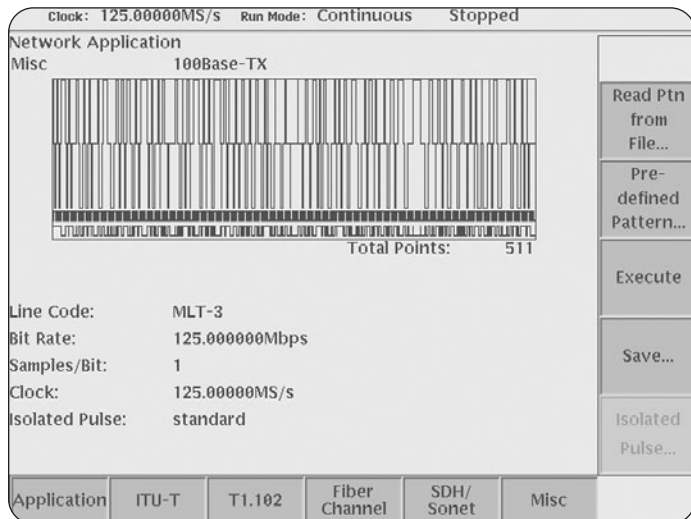

► **Figure 33.** Data import function.

XYZs of Signal Sources

▶ Primer

Creating Waveforms Using Mixed Signal Sources

Today's advanced mixed signal sources, particularly AWGs, offer several ways to create and edit waveforms. In addition, some instruments include application-specific waveforms that are ready to use. Figure 35 illustrates the steps required to generate a signal using an AWG.

Waveform files, once created, are usually stored permanently. The waveforms (or segments thereof) have a way of becoming useful again long after the original application work is completed. Consequently, AWGs designed for engineering work have a local hard disk that stores wave files and sequences permanently. The first step in creating a waveform, then, is to assign a destination for the files.

The waveform editing or creation step is assisted by a host of user-friendly editors. The Waveform Editor uses basic “raw” waveform segments and provides tools to modify them in various ways, including math operations, cut-and-paste, and more.

The Pattern Editor is optimized to manipulate digital data waveforms. While a true pattern generator is usually the right tool for digital work, the AWG's Pattern Editor makes it possible to isolate single bits and change their timing or amplitude parameters – something no digital generator can do.

The Text/Equation Editor uses equations to produce waveforms. Examples range from simple sine formulas to logarithmic swept functions and more. Here too, cut-and-paste editing simplifies development of complex waveforms.

Many AWG users will choose a preset application-specific waveform such as a disk drive Read channel signal or a modulated signal. This is often the fastest way to get “up and running” when deadlines are looming. Note that

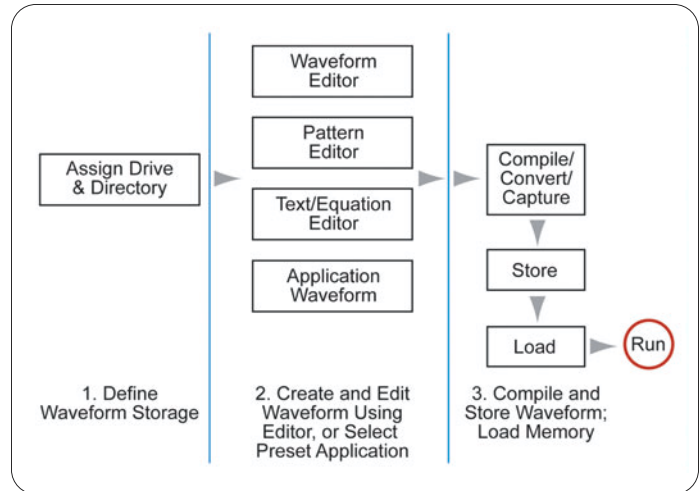

▶ **Figure 35.** Steps to create waveforms using an AWG.

the presets can be altered or distorted using the Waveform Editor, speeding the task of stress testing.

The last step in setting up the AWG is to compile files where necessary (as with files from the Equation Editor) and store the compiled files on the hard disk. The “Load” operation brings the waveform into the AWG's dynamic memory, where it is multiplexed and sent to the DAC before being output in its analog form.

These are the basic steps to produce a waveform on an AWG. As explained earlier, waveform files can be concatenated into sequence in a separate Sequence Editor, yielding a signal stream of almost unlimited length and any degree of complexity.

▶ Logic Signal Sources

Types of Logic Signal Sources

Logic sources are more specialized tools for those with specific digital test requirements. They meet the special stimulus needs of digital devices that require long, continuous streams of binary data, with specific information content and timing characteristics. Logic sources fall into two classes of instruments – pulse generators and pattern generators.

Pulse Generator

Pulse generators drive a stream of square waves or pulses from a small number of outputs, usually at very high frequencies. Unless the stream is modulated, there is usually no information content (data) expressed in the pulses. However, the high frequency and fast rise time capabilities of an advanced pulse generator make it an ideal tool to test high-speed digital equipment.

Pattern Generator

Where the AWG and AFG are primarily designed to produce waveforms with analog shapes and characteristics, the pattern generator's mission is to generate volumes of binary information. The pattern generator, also known as a data generator or data timing generator, produces the streams of 1s and 0s needed to test computer buses, microprocessor IC devices, and other digital elements.

In the design department, the pattern generator is an indispensable stimulus source for almost every class of digital device. In broader terms, the pattern generator is useful for functional testing, debug of new designs, and failure analysis of existing designs. It's also an expedient tool to support timing and amplitude margin characterization.

The pattern generator can be used early in the product development cycle to substitute for system components that are not yet available. For example, it might be programmed to send interrupts and data to a newly developed bus circuit when the processor that would normally provide the signals doesn't yet exist. Similarly, the pattern generator might provide addresses to a memory bus, or even the digital equivalent of a sine wave to a DAC under test.

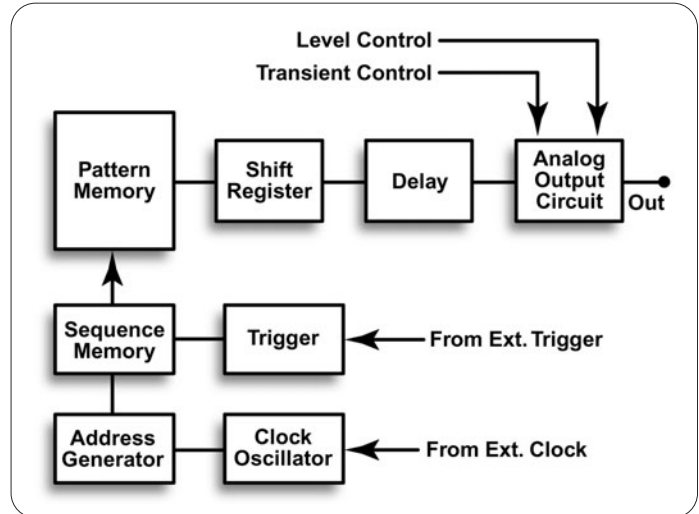

▶ **Figure 36.** The architecture of a pattern or data generator (simplified).

With its extraordinarily long patterns and its ability to implant occasional errors in the data stream, the pattern generator can support long-term reliability tests to ensure compliance with military or aerospace standards. In addition, its ability to respond to external events from the DUT as part of the pattern sequence provides even more flexibility in demanding characterization applications.

The pattern generator is equally at home testing semiconductor devices such as ASICs and FPGAs, or rotating media – hard-disk drive write circuits and DVDs. Likewise, it's useful to test CCD image sensors and LCD display drivers/controllers. The pattern generator is an effective solution just about anywhere that complex digital bit streams are needed to stimulate a DUT.

Like the AWG and AFG, the pattern generator's architecture contains an address generator, a waveform (or pattern) memory, shift register, etc. However, the DAC is absent from the pattern generator's architecture. The DAC is not necessary because the pattern generator does not need to trace out the constantly shifting levels of an analog waveform. Although the pat-

XYZs of Signal Sources

► Primer

tern generator has an analog output circuit, this circuit is used to set voltage and edge parameters that apply to the whole pattern – most pattern generators provide a way to program the logic 1 and 0 voltage values for the pattern.

The pattern generator has some digital features designed to support jitter and timing tests. A special delay circuit is responsible for implementing the small changes in edge positioning these applications require.

The delay circuit can deliver tiny changes (on the order of picoseconds) in edge placement. Some state-of-the-art pattern generators provide simple front-panel controls that allow you to move all edges or selected edges in 5 ps steps within a range of ± 100 ps. These small timing changes model the classic jitter phenomenon in which the placement of a pulse edge in time moves erratically about a nominal center point. You can test jitter tolerance by changing and observing the effects of edge timing in relation to the clock.

In today's best pattern generators, it's possible to apply this jitter throughout the pattern, or on isolated pulses via a masking function that pinpoints specific edges. Figure 37 shows a digital phosphor oscilloscope (DPO) capture of a pattern generator's output signal with the addition of the jitter effect. The inset illustration provides a simplified and enlarged view of the same events.

Other features give the modern pattern generator even more flexibility for critical jitter testing. Some instruments have an external analog modulation input that controls both the amount of edge displacement (in picoseconds) and the rate at which it occurs. With so many jitter variables at your disposal, it's possible to subject the DUT to a wide range of real-world stresses.

The delay circuit plays a second, equally important role in testing for timing problems such as setup-and-hold violations. Most clocked devices require the data signal to be present for a few nanoseconds before the clock pulse appears (setup time), and to remain valid for a few nanoseconds (hold time) after the clock edge. The delay circuit makes it easy to implement this set of conditions. Just as it can move a signal edge a few picoseconds

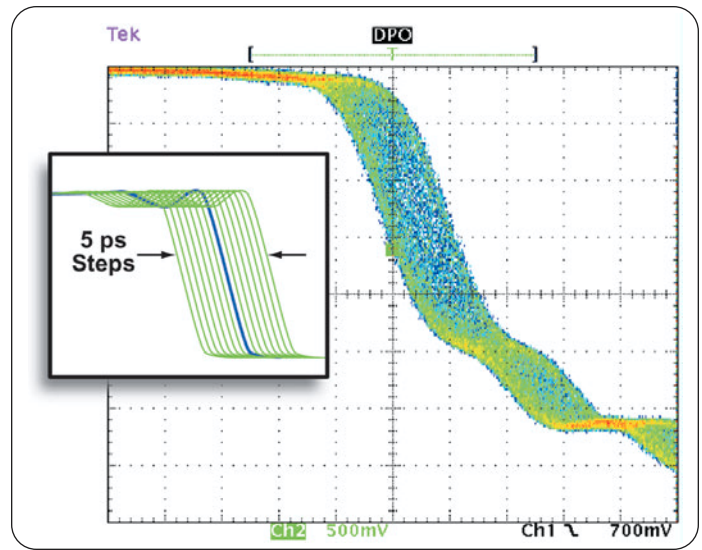

► **Figure 37.** The pattern generator uses small timing shifts to simulate jitter.

at a time, it can move that edge in hundreds of picoseconds, or in nanoseconds. This is exactly what is needed to evaluate setup-and-hold time. The test involves moving the input data signal's leading and trailing edges, respectively, a fraction of a nanosecond at a time while holding the clock edge steady. The resulting DUT output signal is acquired by an oscilloscope or logic analyzer. When the DUT begins to put out valid data consistent with the input condition, the location of the leading data edge is the setup time. This approach can also be used to detect metastable conditions in which the DUT output is unpredictable.

Although the pattern generator's repertoire does not include common signal conditioning operations such as filtering and modulation, it nevertheless offers some tools to manipulate the output signal. These features are needed because digital design problems are not limited to purely digital issues such as jitter and timing violations. Some design faults are the result of analog phenomena such as erratic voltage levels or slow edge rise times. The pattern generator must be able to simulate both.

Voltage variations in the stimulus signal are a key stress-testing tool. By exercising a digital DUT with varying voltage levels, especially levels immediately below the device's logic threshold, it is possible to predict the device's performance and reliability as a whole. A DUT with intermittent (and difficult to trace) failures will almost certainly turn into a "hard" failure when the voltage is reduced.

Figure 38 depicts the effect of programming a pattern generator to produce several discrete logic levels. Here the results of several instructions are shown cumulatively, but in reality, the instrument applies a single voltage level throughout the pattern.

Edge transition times, or rise times, are another frequent cause of problems in digital designs. A pulse with a slow edge transition may not trigger the next device in line in time to clock in data. Slow edges are notorious for causing race conditions, another cause of intermittent failures. A host of cumulative design factors, notably distributed capacitance and inductance, can degrade the rise time of a pulse as it travels from source to destination. Therefore, engineers try to ensure that their circuits can handle a range of rise times. Like voltage variations, slowing down the pulse edge rate is part of every stress and margin testing plan. Since the pattern generator is a common tool in digital design environments, it's often called upon to simulate these transition-time problems. Using the Transient Control feature that feeds the analog output circuit, as shown in the pattern generator block diagram in Figure 36, the user can program a broad range of edge rates for the instrument's output signal. Figure 39 illustrates the effect of the programmable edge rate feature.

Because it is dedicated to digital testing applications, the pattern generator's features give it unique strengths that neither AWGs nor AFGs can match, such as its sophisticated sequencer, multiple outputs, various pattern data sources and distinctive display.

No internal memory can be deep enough to store the many millions of pattern words (also known as vectors) required for a thorough digital device test. Consequently, pattern generators are equipped with sophisticated sequencers – an absolute necessity in the world of data and pattern generation. The pattern generator must provide tremendously long and complex patterns, and must respond to external events – usually a DUT output condition that prompts a branch execution in the pattern generator's

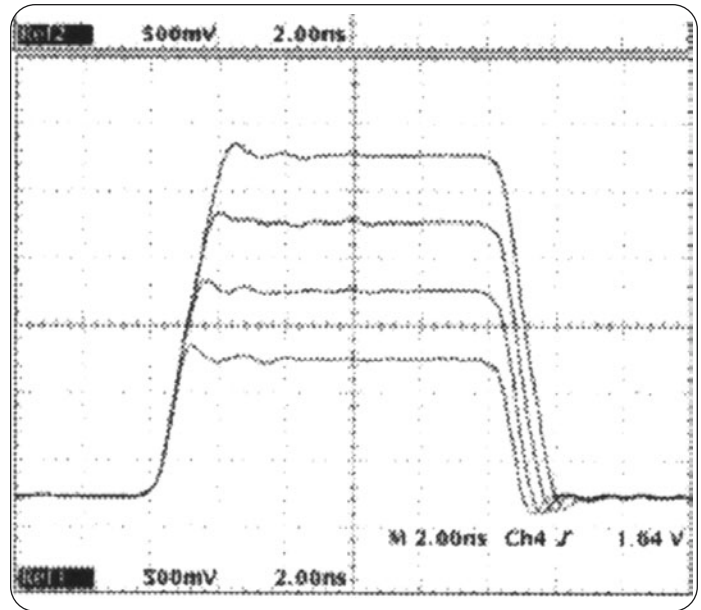

► **Figure 38.** Programmed voltage variations on a pattern generator's output signal. applies a single voltage level throughout the pattern.

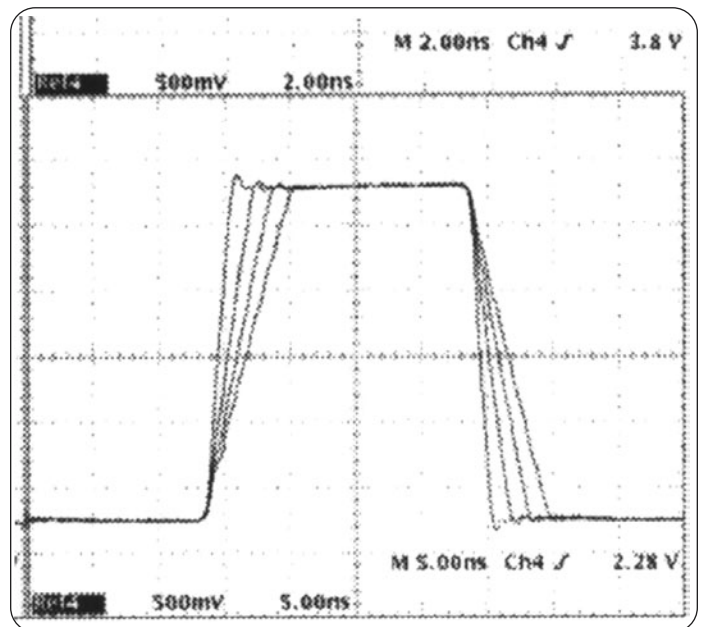

► **Figure 39.** Programmed rise time variations on a pattern generator's output signal.

XYZs of Signal Sources

► Primer

sequencer. Although the pattern generator's pattern memory capacity, typically about 256 Kb maximum, may seem modest in comparison to the largest AWG waveform memory, it, like the AWG, has the ability to loop on short pattern segments to produce a data stream of much greater length. It can wait for an external event or trigger, then execute a series of repeat counts or conditional jumps. In addition, the pattern generator's sequencer offers many levels of loop nesting and branch conditions. It is a tool that can be controlled using normal programming conventions, and produces address, data, clock, and control signals for almost any imaginable digital device. The pattern generator's sequencer has the unique ability to expand pattern length indefinitely. Follow the flow in Figure 40 to see how a few short instructions and pattern segments can unfold into millions of lines of stimulus data.

Multiple outputs also make the pattern generator ideal for digital design applications. Where the AWG or AFG may have two or four outputs, the pattern generator may have hundreds of output channels to support the numerous data and/or address inputs of the typical digital device.

Because a complex digital pattern would be impossibly tedious and error-prone if entered by hand, the modern pattern generator must accept data from logic analyzers, oscilloscopes, simulators, and even spreadsheets. Moreover, digital data is usually available from various simulation and verification steps in the design process.

The pattern generator display must also emphasize the details of many channels of pattern data simultaneously rather than the details of signal amplitude vs. time (as with the AWG display). It should offer markers, scrolling, and other time-saving features to help the user focus on the data of interest. Figure 41 is an example of a multi-channel pattern generator display.

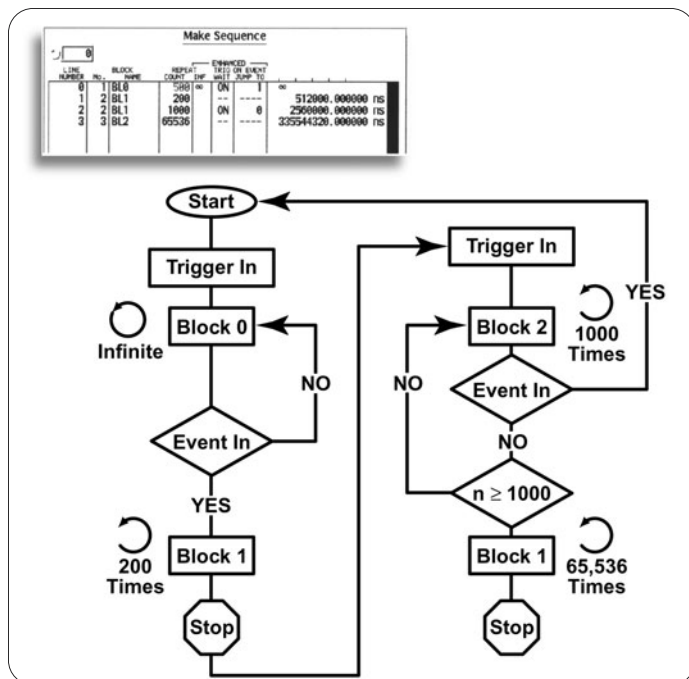

► **Figure 40.** Pattern generator's sequence flow, showing loops and conditional events.

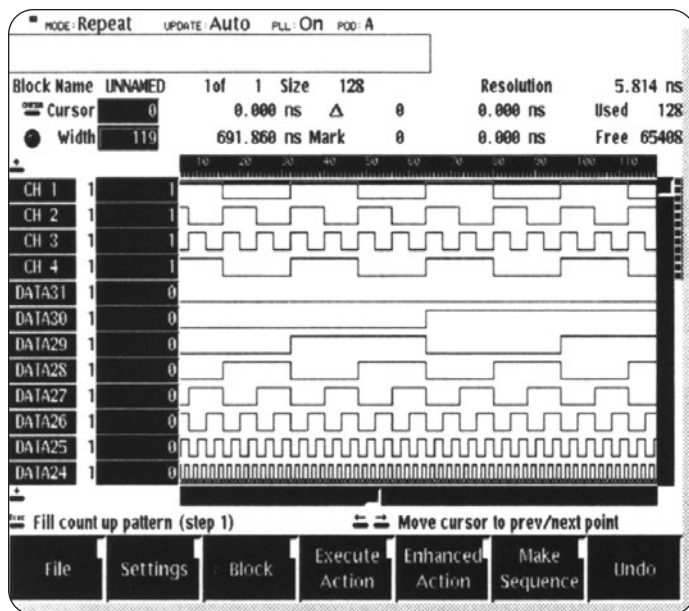

► **Figure 41.** Multi-channel pattern generator's bus timing display.

Finally, pattern generators are often used in tests that require critical pulse edge characteristics, including voltage accuracy, rise time performance, and edge placement. Unfortunately, simply providing a high quality signal at the instrument's front-panel connector is not enough. Often the signal must travel to a test fixture a meter or more away from the instrument, through cables and connectors that can seriously degrade the signal's timing and edge details. Some modern pattern generators solve this problem with an external signal interface that buffers the signal and brings the performance of the instrument all the way out to the DUT. Figure 42 shows a typical pattern generator equipped with a signal interface. The interface minimizes rise time degradation due to cable capacitance and provides ample local current to drive a DUT input without "loading down."

The Systems and Controls of a Logic Signal Source

Figure 43 illustrates an advanced logic signal source, the Tektronix DTG5000 Data Timing Generator.

A logic source, like a mixed-signal source, offers a mix of menu-based operations plus front-panel direct access buttons to speed manipulation of common functions such as timing and level setting. A state-of-the-art logic source will incorporate specialized, user-friendly functions that serve digital needs, plus extensive pattern development tools that are appreciably different from their AWG counterparts.

The **Timing Control screen** shown in Figure 44 reflects the Windows-based architecture of the depicted instrument. Other models use proprietary interfaces of various types. The Windows environment has the advantage of providing easy connectivity to industry-standard networks, peripherals, and I/O buses such as USB. As explained earlier in the AWG section, the Editing/Control screen is the viewing medium to create pattern sequences, level settings, and general data entry. Some logic sources pro-



▶ **Figure 42.** Pattern generators and external signal interface "pod".

vide (in addition to the integrated display) a separate VGA output that can be used to drive larger external monitors.

Many instruments provide front-panel **Shortcut buttons** for the most commonly-adjusted functions: setting data values, and setting timing and amplitude values. These buttons eliminate the need to go through a series of menus to set the values, saving time.

The **Run/Stop Sequence** button initiates a stored sequence. Assuming certain conditions are in effect, pressing the button causes the pattern data to begin streaming from the main output connectors. Normally the assumed conditions are: a trigger exists (provided by either the **Manual Trigger** button or the **External Trigger** input); and the output is enabled via the **Output On/Off** button. The Output On/Off button is typically used to shut off the output signal when developing a test program, to prevent the data from being sent to a connected DUT.

XYZs of Signal Sources

► Primer

The **Menu/Navigation** keys, the **Scrolling Knob**, and the **Numeric Keypad** are used for program development. The Menu/Navigation keys open menus, while the Scrolling Knob and Keypad facilitate numeric data entry – timing values, binary data, and more.

Modular outputs are becoming the preferred solution to the diverse (and evolving) electrical requirements of today's logic families and bus architectures. Modules can be optimized for the specific impedance, current, and voltage parameters of a particular logic family, ensuring the highest possible precision in the range of interest. Moreover, modular outputs spare the cost of unneeded modules. Instruments can be populated with as few as four outputs, or as many as 32.

Not seen on the front panel, but still important, is a brace of synchronization outputs on the back panel. These may include an industry-standard 10 MHz clock, a copy of the system clock signal (running at the logic source's current frequency), and even a phase-lock loop output that delivers a signal at multiples of the main clock. All of these signals can be used to synchronize acquisition instruments, the DUT itself, or even other signal sources. Note that a front-panel Sync Output is also available for routine sync duties.

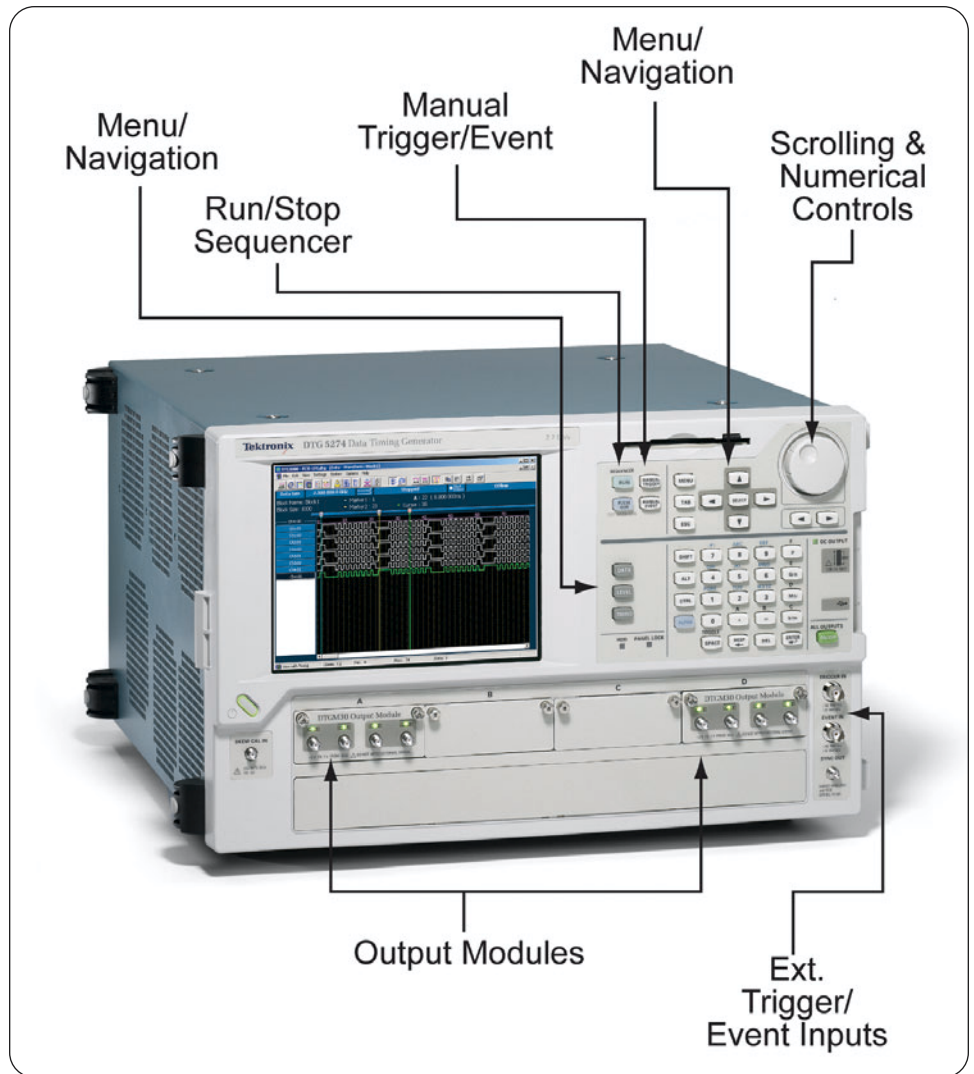

► **Figure 43.** A high-performance logic source: the Tektronix DTG5274 Data Timing Generator.

Performance Terms and Considerations

Digital signal sources share many performance parameters with their analog counterparts, the AWG and AFG.

Data Rate

Data rate denotes the rate at which a digital signal source can output full cycles of binary information. The actual data bit within the cycle may or may not change state. The time between the boundaries of the cycle determines the data rate in megabits or gigabits per second.

Pattern Depth

Like the memory depth of an AWG, pattern depth determines the maximum amount of data that can be stored to support pattern generation. A deeper memory can store more pattern variations. The digital signal source relies on sequencing techniques to create almost endless combinations of pattern words.

Rise/Fall Time

The rise or fall time refers to the amount of time required for a pulse edge to make a transition to a state opposite its current level. Some digital signal sources allow this parameter to be varied in accordance with the needs of differing logic families.

Vertical (Amplitude) Resolution

Vertical (amplitude) resolution refers to the smallest increment of voltage change that can be programmed in the signal source. In the digital context, this figure pertains to the logic levels that are set up for a given device family. Though nominally “fixed,” the levels can be modified within a certain range to allow stress testing (such as under-voltage tests). The vertical resolution determines the increments of this change.

Horizontal (Timing) Resolution

Horizontal (timing) resolution references the minimum increment of time by which an edge, cycle time, or pulse width can be changed.

Output Channels

Digital pattern sources, unlike their analog counterparts, typically drive many DUT inputs at once. A single digital component or bus may require 8, 16, or more outputs from a signal source. The instrument should provide a means of aggregating these signals into groups in which many signals can be manipulated as one. A common example is the assignment of all address signals to one group, all data signals to another, and Write Enable

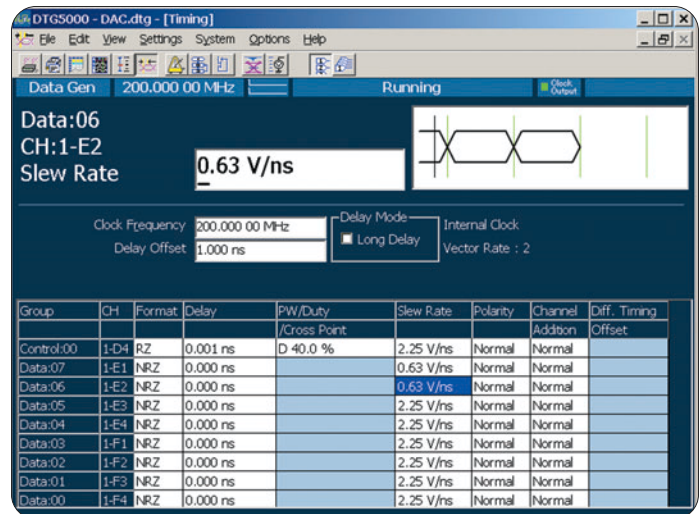

► **Figure 44.** Editing/control screen.

signals to yet another group. With this format, it is possible to reduce the voltage on all of the address lines at once, as in stress testing.

Sequencing

Sequencing is the foundation of digital pattern generation. Using computer constructs such as jumps and loops, the source’s internal sequencer can switch among many discretely defined blocks of pattern data. A block is simply a reusable segment of some specified length, such as 512 cycles. This creates a vast number of variations that can be used to exercise a digital device thoroughly.

Integrated Editors

To make digital pattern editing practical, editing tools are required. Some high-performance digital signal sources provide integrated editing features that make an external computer and editor unnecessary. These editors allow you to set up both clock and data streams, presenting a literal view of the waveforms on the instrument’s screen. Alternatively, table editors use a familiar spreadsheet format to allow pattern construction using common cut-and-paste editing techniques.

Data Import Functions

Today’s digital pattern sources can import digital patterns from EDA systems and other instruments. This is a valuable aid to design validation, since it eliminates the need to develop patterns specifically for prototype verification and saves a time-consuming step.

XYZs of Signal Sources

▶ Primer

Creating Waveforms Using a Logic Signal Source

Developing a “waveform” to be used as a digital stimulus pattern requires a different procedure from its equivalent in the analog realm. In a high-performance logic source, the process is one of defining groups of similar signals, applying the clock and data patterns, and setting logic levels.

Figure 45 is a simplified flow chart that summarizes the steps involved in creating a digital stimulus signal using a logic signal source.

In keeping with the needs of digital devices, the logic source allows grouping of data channels to match the device’s input and output pins. By this means, the information stored in the instrument’s memory can be distributed to selected output channels. Most digital DUTs will have groups of clock, address, and data pins, and these can be mapped to equivalent channel groups in the logic source. This architecture makes it easy to change values such as voltage or delay on an entire group of pins at once, rather than one at a time.

The next step is to create pattern “blocks” that will make up the sequence. A block is a pattern burst of a selected length, such as 1024 bits. The normal approach is to create a batch of blocks that can be used in various combinations as the test sequence proceeds.

After defining an appropriate number of blocks, you must fill the blocks with data. Some logic sources offer libraries of predefined patterns in classic formats: “Walking Ones,” “Checkerboard,” “Grey Code,” and so forth. By alternating blocks containing these differing patterns, it is possible to stress the DUT with a huge number of pattern variations. A built-in

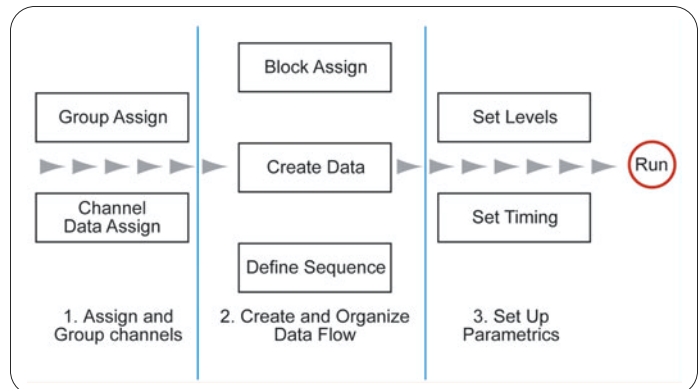

▶ **Figure 45.** Steps to create digital signals using a logic signal source.

sequence editor helps out with this task. Programming a sequence is a simple matter of filling in a table with instructions as to the block order, the number of repeats, and other conditions such as jumps and Go To statements.

The final step in creating a signal is to specify the logic voltages and timing conditions that will be applied to the DUT. There are many different logic device families in the world today, and just as many differing requirements for drive levels. Fortunately, today’s advance digital signal sources offer preconfigured settings to meet these needs (user-programmed settings are also possible). Other variables include termination impedances and terminating voltages, data formats (RZ, NRZ, etc.), clock frequency, edge delays, and more. Again, simple tables are the means for entering all this data.

▶ Conclusion

Many engineers look at tasks like troubleshooting and design verification as purely “measurement” challenges, and tend to think reflexively of their oscilloscope or logic analyzer as the whole solution to the problem. But these acquisition instruments have an important partner in their work: the stimulus instrument – the signal source.

Stimulus and acquisition instruments together make up a complete solution that can drive a device-under-test with complex real-world signals and acquire the resulting outputs. The oscilloscope is the industry-standard tool for acquisition. But only with a signal source can engineers really control what goes into the device. And that is often a necessity for making sense of what comes out of the device.

Similarly, the signal source makes margin testing and characterization possible. Working with a signal source and an oscilloscope or logic analyzer, engineers can explore the limits of their design’s performance – introducing deliberate stresses with the source and measuring the results with the oscilloscope, or capturing data with the logic analyzer when digital errors occur.

In applications ranging from disk drive design to telecommunications conformance testing, the signal source and the acquisition instruments work together as a complete measurement solution

▶ Glossary

Aberration – Overshoot or undershoot in a waveform.

Agility – The ability to change quickly and cleanly from one frequency to another.

Aliasing – The intrusion of distorted conversion by-products into the frequency range of interest.

Amplitude – The magnitude of a quantity or strength of a signal. In electronics, amplitude usually refers to either voltage or power.

Amplitude Modulation (AM) – A type of analog modulation in which amplitude variations embed lower-frequency information into a carrier signal of higher frequency; most commonly used in broadcast communications.

Amplitude Resolution – See Vertical Resolution.

Amplitude Shift Keying (ASK) – A type of digital modulation in which the digital modulating signal causes the output frequency to switch between two amplitudes.

Analog Signal – A signal with continuously variable voltages.

Analog-to-Digital Converter (ADC) – A digital electronic component that converts continuous analog signals into proportional discrete binary (digital) values.

Arbitrary – A waveform defined by individual preference or convenience rather than by the intrinsic nature of the signal generator.

Arbitrary Function Generator (AFG) – A type of analog/mixed-signal source that produces stable waveforms in standard shapes.

Arbitrary Waveform Generator (AWG) – A type of analog/mixed-signal source in which an output of the arbitrary analog signals created on memory is possible; a sophisticated playback system that delivers waveforms based on stored digital data that describes the constantly changing voltage levels of an AC signal.

Attenuation – A decrease in signal amplitude during its transmission from one point to another.

Bandwidth – A frequency range, usually limited by -3 dB.

Block – A pattern burst of a selected length, such as 1024 bits, that comprises a digital sequence output by a logic signal source.

Characterization – A common application in which a signal source is used to determine the operating limits of a component, device or system; an application in which stress testing, or margin testing, is a part of the activity conducted.

Clock Generator – A signal source that can output only a rectangle wave; used primarily as a clock source.

Clock Rate – See Sample Rate.

Complementary Output – An output that uses two signal paths to carry copies of the same signal in equal amplitude and 180 degrees out of phase.

Continuous Mode – An operating mode within a signal source in which the output begins immediately, beginning at the head of the waveform or sequence and repeating until turned off.

Cursor – An on-screen marker that you can align with a waveform to make more accurate measurements; in a signal source, a cursor is used to select an area of a waveform between which the waveform can be modified.

Damped Sine Wave – A type of sine wave in which a circuit oscillates from an impulse, and then winds down over time.

Data Generator – A type of signal source that generates single or multiple streams of digital patterns; also known as a pattern generator.

Data Rate – The rate at which a digital signal source can output full cycles of binary information, usually specified in terms of megabits or gigabits per second.

DC Accuracy – The difference of the set-up voltage and actual output voltage.

Delay – The difference in timing between two otherwise similar signals; also known as phase shift.

Delayed Non-Return-to-Zero (DNRZ) – A common digital pattern in which the waveform switches to a "1" after a specified time delay when a valid bit occurs in the cycle and stays at that value until the next cycle boundary, assuming that the cycle originated with a binary "0".

Device-under-test (DUT) – A device for measuring; synonymous with a unit-under-test (UUT).

Differential Output – An output that uses two signal paths to carry copies of the same signal of equal amplitude and 180 degrees out of phase, where the amplitude is measured relative to each other and not to ground.

Digital Pattern – Multiple synchronized pulse streams that comprise "words" of data that may be 8, 12, 16 or more bits wide.

Digital Signal – A signal whose voltage samples are represented by discrete binary numbers.

Digital Waveform Generator – A type of signal source that outputs digital patterns; also known as a logic signal source.

Digital-to-Analog Converter (DAC) – A digital electronic component that converts discrete binary values into an electrical signal.

Direct Digital Synthesizer (DDS) Technology – Technology that synthesizes waveforms by using a single clock frequency to spawn any frequency within the instrument's range; determines the rate at which samples are clocked out of a signal source's memory.

Distortion – A by-product of circuit realities, like distributed capacitance, crosstalk, and more.

Duty Cycle – The variation of a wave or pulse in which the high and low time intervals are not of equal length; the ratio of the positive duration of a pulse to its negative or zero duration.

Equation Editor – An integrated math tool within a signal source that allows you to enter variables and operators; the instrument then checks the syntax, and compiles and stores the resulting waveform.

Event Input – Used in conjunction with the sequencing function of a signal source. Upon receiving an event input signal (a TTL logic signal) the signal source will jump to the next line or waveform in a sequence.

Fall Time – Amount of time required for a pulse edge to make a transition to a state opposite its current level; in the case of rise time, from low level to high level and, in the case of fall time, from high level to low level.

Filtering – The process by which a signal source removes selected bands of frequency from a signal; can be used to prevent unwanted aliasing distortion in the DUT output.

Flatness – The degree which changes level with output frequency when outputting a sine wave.

Frequency – The number of times a signal repeats in one second, measured in Hertz (cycles per second). Frequency equals 1/period.

Frequency Modulation (FM) – A type of analog modulation in which frequency variations embed lower-frequency information into a carrier signal of higher frequency; most commonly used in broadcast communications.

Frequency Shift Keying (FSK) – A type of digital modulation in which the carrier switches between two frequencies, its center frequency and an off-set frequency.

Function Generator (FG) – A type of signal source that outputs fundamental waves, such as a sine wave or a rectangle wave.

Gigahertz (GHz) – 1,000,000,000 Hertz; a unit of frequency.

Glitch – An intermittent, high-speed error in a circuit or waveform.

Graphic Editor – An integrated tool within a signal source that allows you to construct and view a literal representation of the waveform; the resulting data points are then compiled and stored in the waveform memory.

Horizontal Resolution – The smallest time increment that can be used to create waveforms; the minimum increment of time by which an edge, cycle time, or pulse width can be changed.

Horizontal System – Within a signal source, the system that defines the frequency of the output signal by controlling the sample rate.

Integrated Editor – An integrated editing tool within a signal source that enables easy editing and modification of waveforms in both time and amplitude.

XYZs of Signal Sources

▶ Primer

Inter-symbol Interference – The distortion or alteration of a signal within one cycle caused by the influence of a signal's state in the preceding cycle.

Jitter – A type of impairment that indicates that a cycle or frequency is not stabilized.

Kilohertz (kHz) – 1,000 Hertz; a unit of frequency.

Logic Analyzer – An instrument used to make the logic states of many digital signals visible over time; an instrument that analyzes digital data and can represent the data as real-time software execution, data flow values, state sequences, etc.

Logic Signal Source – A type of signal source that outputs digital patterns, such as a pulse or pattern generator.

Margin Testing – A common application in which a signal source is used to stress components, devices or systems with impairments, such as jitter and timing violations, to determine their operating limits, also known as stress testing.

Marker – The auxiliary output of a signal source that is separated from its main outputs; an auxiliary digital channel that can be used as a trigger signal for the DUT; an auxiliary digital channel that can be used to output a serial digital pattern.

Marker Output – A type of digital output that provides a binary signal that is synchronous with the main analog output signal, typically driven from a memory that is independent of the main waveform memory.

Megahertz (MHz) – 1,000,000 Hertz; a unit of frequency.

Megasamples per second (MS/s) – A sample rate unit equal to one million samples per second.

Memory Depth – The number of waveform points used to create a record of a signal, which determines the maximum amount of waveform data (equivalent to time) that can be stored by an analog/mixed-signal source.

Microsecond (μ s) – A unit of time equivalent to 0.000001 seconds.

Millisecond (ms) – A unit of time equivalent to 0.001 seconds.

Mixed Signal Source – A type of signal source, such as an arbitrary waveform generator or arbitrary function generator, that outputs both analog waveforms and digital patterns.

Modulated Signal – A signal in which amplitude, phase, and/or frequency variations embed lower-frequency information into a carrier signal of higher frequency.

Nanosecond (ns) – A unit of time equivalent to 0.000000001 seconds.

Noise – An unwanted voltage or current in an electrical circuit.

NRZ (Non-Return-to-Zero) – A common digital pattern in which the waveform switches to a "1" when a valid bit occurs in the cycle and stays at that value until the next cycle boundary, assuming that the cycle originated with a binary "0".

Nyquist Sampling Theorem – A theorem that states that the sampling frequency, or clock rate, must be at least twice that of the highest frequency component of the sampled signal to ensure accurate signal reproduction.

Offset – DC component of a signal that contains both AC and DC values; voltage between circuit ground and the center of a signal's amplitude.

Offset Level – The vertical displacement (in volts) of a waveform from its zero or ground level.

Output Signal – The waveform, pattern, or sequence file that has been loaded into memory and given a run command; the signal that passes through the front-panel output connectors.

Parallel Digital Output – A type of digital output that takes digital data from the same memory as the signal source's main analog output and stores the digital equivalent of the waveform sample value present on the analog output.

Pattern – See Digital Pattern.

Pattern Depth – The number of waveform points used to create a record of a signal, which determines the maximum amount of data (equivalent to time) that can be stored by a logic signal source to support pattern generation.

Pattern Editor – An integrated editing tool within a signal source that makes it possible to modify and edit patterns in both time and amplitude.

Pattern Generator – A type of logic signal source that generates the digital pattern of many channels; also known as a data generator.

Peak (V_p) – The maximum voltage level measured from a zero reference point.

Peak-to-peak (V_{p-p}) – The voltage measured from the maximum point of a signal to its minimum point.

Period – The amount of time it takes a wave to complete one cycle. The period equals $1/\text{frequency}$.

Phase – The amount of time that passes from the beginning of a cycle to the beginning of the next cycle, measured in degrees.

Phase Modulation (PM) – A type of analog modulation in which phase variations embed lower-frequency information into a carrier signal of higher frequency; most commonly used in broadcast communications.

Phase Shift – The difference in timing between two otherwise similar signals, also known as delay.

Phase Shift Keying (PSK) – A type of digital modulation in which the carrier switches between two phase settings.

Polarity – The direction in which current flows relative to its zero or ground level; usually refers to the starting direction, positive or negative, of a waveform.

Pseudo-random Bit Stream (PRBS) – A set of sequences, which consists of a stream of numbers that appear random but follow a predictable mathematical pattern, repeated at a random rate; used to create random noise in digital systems.

Pseudo-random Word Stream (PRWS) – A word stream that defines how multiple pseudorandom bit streams are presented across all of the signal source's parallel outputs, often used when testing serializers or multiplexers.

Pulse – A common waveform shape that has a fast rising edge, a width, and a fast falling edge.

Pulse Generator – A type of logic signal source that can drive a stream of square waves or pulses from a small number of outputs, usually at very high frequencies.

Pulse Train – A collection of pulses traveling together.

Pulse Width – The amount of time the pulse takes to go from low to high and back to low again, conventionally measured at 50% of full voltage.

Pulse Width Modulation (PWM) – A type of digital modulation in which the modulating signal causes the active pulse width of the pulse to vary, applicable to pulse waveforms only; commonly used in digital audio systems.

Quadrature (IQ) Modulation Technology – A type of modulation in which two carriers, an in-phase (I) waveform and a quadrature-phase (Q) waveform, are combined and transmitted over one channel, then separated and demodulated at the receiving end; commonly found in today's wireless communications networks.

Ramps – Transitions between voltage levels of sine waves that change at a constant rate.

Record Length – The number of waveform points used to create a record of a signal, referred to as memory depth in analog/mixed-signal sources and pattern depth in logic signal sources.

Rectangular Wave – A wave in which the switching characteristics are similar to those of a square wave, except that the high and low time intervals are not of equal length.

Region Shift – A function found within an analog/mixed-signal source that shifts a specified edge of a waveform either right or left, toward or away from the programmed center value, making it possible to create simulated jitter conditions and other tiny edge placement changes that exceed the resolution of the instrument.

Replication – A method used to develop a waveform for use by a signal source that involves capturing an existing signal on an oscilloscope and sending it to the signal source for reproduction.

Return-to-One (R1) – A common digital pattern in which the waveform switches to a "0" when a valid bit is present and then switches back to a "1" within the same cycle, assuming that the cycle originated with a binary "1"; the inverse of RZ.

XYZs of Signal Sources

▶ Primer

Return-to-Zero (RZ) – A common digital pattern in which the waveform switches to a "1" when a valid bit is present and then switches back to a "0" within the same cycle, assuming that the cycle originated with a binary "0".

Rise Time – Amount of time required for a pulse edge to make a transition to a state opposite its current level; in the case of rise time, from low level to high level and, in the case of fall time, from high level to low level.

Sampling – The process used to define a signal using samples, or data points, that represent a series of voltage measurements along the slope of a waveform.

Sample Point – Data points that represent a series of voltage measurements along the slope of a waveform; the raw data from an ADC used to calculate waveform points.

Sample Rate – The rate at which an analog/mixed-signal source can output full waveform cycles, usually specified in terms of megasamples or gigasamples per second; also known as clock rate or sampling frequency.

Sawtooth Wave – A wave in which the voltage ramps up slowly and evenly to a peak in each cycle, then falls off quickly.

Screen – The surface of the display upon which the visible pattern is produced – the display area.

Sequence Editor – An integrated tool within a signal source that contains computer-like programming instructions (jumps, loops, etc.) that reside in a sequence memory separate from the waveform memory and cause specified segments of the waveform memory to repeat.

Sequence Repeat Counter – A control mechanism used in the sequencing process to determine the number of operational cycles and the order in which they appear.

Sequencing – The process by which a signal source creates waveforms of almost unlimited length by storing a large number of "virtual" waveform cycles in the instrument's memory and repeating them according to the instructions of the sequence editor.

Signal Fidelity – The accurate reconstruction of a signal, determined by the systems and performance considerations of the stimulus or acquisition instrument.

Signal Modulation – A process in which signal amplitude, phase and/or frequency variations embed lower-frequency information into a carrier signal of higher frequency.

Signal Source – A test device used to inject a signal into a circuit input; the circuit's output is then read by an oscilloscope or logic analyzer; also known as a signal generator.

Simulation – A technique used by a signal source to output a waveform that mimics the output of a device for use in testing another device.

Sine Wave – A common curved wave shape that is mathematically defined.

Single-ended Output – An output that uses one path to carry a signal, relative to ground.

Slope – On a graph or an instrument's screen, the ratio of a vertical distance to a horizontal distance. A positive slope increases from left to right, while a negative slope decreases from left to right.

Spurious Free Dynamic Range (SFDR) – The ratio of the specified maximum signal level capability of the signal source to its noise.

Square Wave – A common wave shape consisting of repeating square pulses; a voltage that switches between two fixed voltage levels at regular intervals.

Step – A waveform that shows a sudden change in voltage.

Substitution – A method used to develop a waveform for use by a signal source that involves creating and/or modifying a defined signal to substitute for a signal from unavailable circuitry.

Swept Sine Wave – A type of sine wave that increases in frequency over some period of time.

Table Editor – An integrated tool within a logic signal source that uses a spreadsheet-like format to allow pattern construction using common cut-and-paste techniques.

Timing Editor – An integrated tool within a logic signal source that allows setup of both clock and data streams, presenting a literal view of the waveforms on the instrument's screen.

Timing Resolution – See Horizontal Resolution.

Transducer – A device that converts a specific physical quantity such as sound, pressure, strain, or light intensity into an electrical signal.

Triangle Wave – A wave in which the voltage exhibits symmetrical rise and fall times.

Trigger – An external signal or front-panel button that tells the signal source when to begin outputting a specified signal.

Trigger Level – The minimum input value, in + or – volts, required by an external trigger input signal to start instrument operation.

Trigger System – Within a signal source, the system that defines the conditions under which the instrument will commence driving signals through its output, assuming it is not running in a continuous mode.

Unit-under-test (UUT) – A unit for measuring; synonymous with a device-under-test (DUT).

Verification – A common application in which a signal source is used to determine whether or not a component, device or system operates as predicted, and conforms to industry standards.

Vertical System – Within a signal source, the system that defines the amplitude and offset level of the output signal.

Vertical Resolution – The smallest increment of voltage change that can be programmed in a signal source; the binary word width, in bits, of the instrument's DAC, which defines the amplitude accuracy and distortion of the reproduced waveform.

Volt – The unit of electric potential difference.

Voltage – The difference in electric potential, expressed in volts, between two points.

Wave – The generic term for a pattern that repeats over time. Common types include: sine, square, rectangular, saw-tooth, triangle, step, pulse, periodic, non-periodic, synchronous, asynchronous.

Waveform – A graphic representation of a wave's activity and its variation over time.

Waveform Point – A digital value that represents the voltage of a signal at a specific point in time, calculated from sample points and stored in memory.

XYZs of Signal Sources

▶ Primer

Contact Tektronix:

ASEAN / Australasia / Pakistan +65 6356 3900
Austria +43 2236 8092 262
Belgium +32 (2) 715 89 70
Brazil & South America 55 (11) 3741-8360
Canada 1 (800) 661-5625
Central Europe & Greece +43 2236 8092 301
Denmark +45 44 850 700
Finland +358 (9) 4783 400
France & North Africa +33 (0) 1 69 86 80 34
Germany +49 (221) 94 77 400
Hong Kong (852) 2585-6688
India (91) 80-2275577
Italy +39 (02) 25086 1
Japan 81 (3) 3448-3010
Mexico, Central America & Caribbean 52 (55) 56666-333
The Netherlands +31 (0) 23 569 5555
Norway +47 22 07 07 00
People's Republic of China 86 (10) 6235 1230
Poland +48 (0) 22 521 53 40
Republic of Korea 82 (2) 528-5299
Russia, CIS & The Baltics +358 (9) 4783 400
South Africa +27 11 254 8360
Spain +34 (91) 372 6055
Sweden +46 8 477 6503/4
Taiwan 886 (2) 2722-9622
United Kingdom & Eire +44 (0) 1344 392400
USA 1 (800) 426-2200
USA (Export Sales) 1 (503) 627-1916
For other areas contact Tektronix, Inc. at: 1 (503) 627-7111

For Further Information

Tektronix maintains a comprehensive, constantly expanding collection of application notes, technical briefs and other resources to help engineers working on the cutting edge of technology. Please visit www.tektronix.com



Copyright © 2003, Tektronix, Inc. All rights reserved. Tektronix products are covered by U.S. and foreign patents, issued and pending. Information in this publication supersedes that in all previously published material. Specification and price change privileges reserved. TEKTRONIX and TEK are registered trademarks of Tektronix, Inc. All other trade names referenced are the service marks, trademarks or registered trademarks of their respective companies.

05/03 TD/BT

76W-16672-0

Other Primers Available from Tektronix:

XYZs of Oscilloscopes
XYZs of Logic Analyzers
Introduction to Logic Analysis: A Hardware Debug Tutorial
ABCs of Probes
Digital Designer's Guide to Signal Integrity
UMTS Protocols and Protocol Testing
GPRS Protocol Testing in the Wireless World
SDH Telecommunications Standards
SONET Telecommunications Standards
DWDM Performance and Conformance Testing
Polarization and PMD Basics
Basics of Laser Diodes
A Guide to Digital Television Systems and Measurements
A Guide to Picture Quality Measurements for Modern Television Systems
A Guide to MPEG Fundamentals and Protocol Analysis
A Guide to Standard and High-definition Digital Video Measurements
Multi-layer Confidence Monitoring in Digital Television Broadcasting
Glossary of Video Terms and Acronyms

www.tektronix.com

Oscilloscopes
Logic Analyzers
Signal Sources
Communications Test Equipment
Video Test Equipment
Probes
Accessories
Other Test and Measurement Equipment

